

ALÜMİNYUM PROFİLİNDE GÜVENİLİR ÇÖZÜMLER

RELIABLE SOLUTIONS
IN ALUMINUM PROFILE

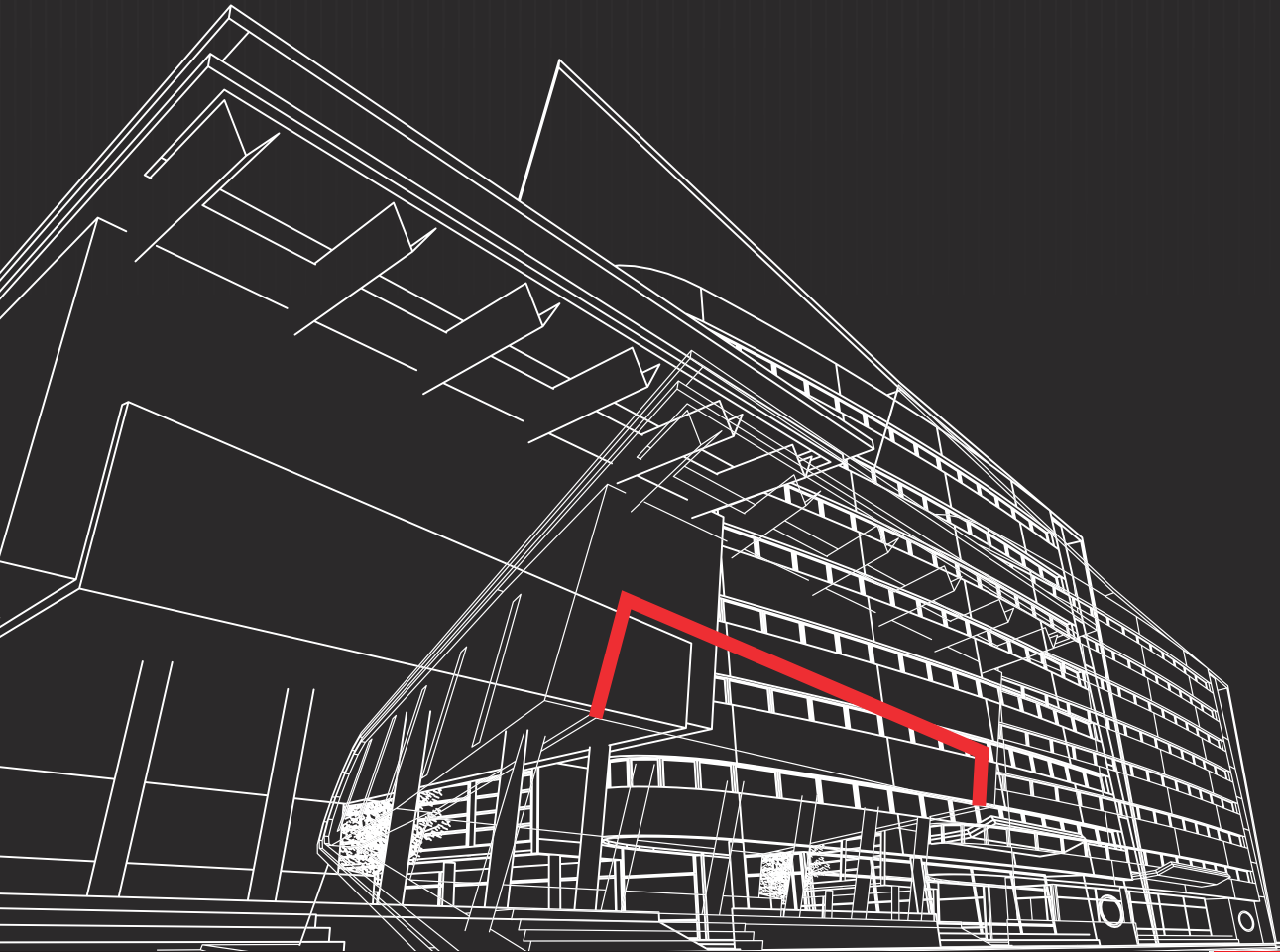



HAKKIMIZDA

Ulusan Alüminyum 1983 yılın da uygulama firması olarak faaliyete başlamıştır, 1990 yılından itibaren sektöre alüminyum profil ve aksesuar satışı ile hizmete devam eden Ulusan 1998 yılında kurmuş olduğu elektrostatik toz boya tesisi ile sanayileşme alanında ilk adımı atmıştır. 24 yıllık satış ve pazarlama deneyimi ile 2007 yılında 1750 ton 7" SMS pres, 2011 yılında 8" SMS 2750 ton pres, 2015 yılında 7" SMS 2000 ton pres hattı yatırımı ve B1-B2 reçete kontrollü karıştırma sistemine sahip kompozit panel üretim hattı yatırımlarını tamamlamış olup, 2018 yılında Türkiye'de ilk pinç valf sistemine sahip stabil boya kalınlığı sağlayan dikey boya tesisi yatırımı gerçekleştirmiştir. Ayrıca tamamlanmış pres yatırımları kapsamında, 2025 yılında 10" SMS 4500 ton pres ve 14" SMS 6600 ton pres, 2024 yılında A2 yanmaz kompozit panel üretim hattını faaliyete geçirecektir. Şu an itibarıyla de faaliyette olan 11,000 ton/ay kapasiteli modern dökümhane tesisi ile hizmet vermektedir. 135000 Amperlik otomasyon kontrollü eloksal kaplama tesisine sahip olan firmamız alüminyum profil sektöründe tüm müşteri taleplerini karşılayabilmektedir. 70000 m² si kapalı olmak üzere 85000 m² alanda faaliyet gösteren tesislerimizde üretim aşamalarının tamamına yakını tam otomatik makinelerle kontrol edilmektedir. Ulusan Alüminyum Anadolu'nun en büyük, Türkiye'de ve Avrupa'da faaliyet gösteren sayılı üreticilerinden biri haline gelmiştir. Ulusan Alüminyum Dünyada ki sektörel gelişmeleri takip etmekte ve günümüz ihtiyaçları doğrultusunda gerekli yatırımları yapmaya devam edecektir.

О НАС

Ulusan Aluminium начала свою деятельность как компания по нанесению покрытий в 1983 году. Ulusan, которая обслуживает этот сектор продаж алюминевых профилей и аксессуаров с 1990 года, сделала свой первый шаг в области индустриализации, открыв в 1998 году предприятие по нанесению электростатического порошкового покрытия.

Имея 24-летний опыт продаж и маркетинга, он осуществил инвестиции в 1750 тонн 7-дюймового пресса SMS в 2007 году, 8-дюймового пресса SMS 2750 тонн в 2011 году, 7-дюймовой прессовой линии SMS 2000 тонн в 2015 году и линии по производству композитных панелей с системой смешивания с контролируемым рецептом B1-B2. В 2018 году компания инвестировала в первый в Турции вертикальный окрасочный цех, который оснащен системой пережимных клапанов и обеспечивает стабильную толщину краски. Кроме того, в рамках завершённых инвестиций в прессы в 2025 году будут введены в эксплуатацию 10-дюймовый пресс SMS усилием 4500 тонн и 14-дюймовый пресс SMS усилием 6600 тонн, а в 2024 году будет введена в эксплуатацию линия по производству огнестойких композитных панелей A2. В настоящее время он располагает современным литейным цехом производительностью 11 000 тонн в месяц. Наша компания, имеющая автоматизированную установку анодирования мощностью 135000 ампер, может удовлетворить все требования клиентов в секторе алюминевых профилей. На наших предприятиях, занимающих площадь 85 000 м², из которых 70 000 м² закрыты, почти все этапы производства контролируются полностью автоматическими машинами.

Ulusan Aluminium стал крупнейшим производителем в Анатолии и одним из немногих производителей, работающих в Турции и Европе. Ulusan Aluminium следит за развитием отрасли в мире и продолжит делать необходимые инвестиции в соответствии с сегодняшними потребностями.

ABOUT US

ULUSAN Aluminium was founded in 1983 and started with installing Windows. In 1990, Ulusan continued selling aluminium profiles and accessories and in 1998 we took the first step in the industrialization field by setting up the plant of electrostatic powder paint. After a 24 years experience in selling, we installed our first press line from "SMS" the well known german company with capacity of 7 inch "7" ton a year. Then our second line "8 inch" 2750 ton and third line with "7 inch" 2000 tons capacity a year. The investment for the composite panel production line with classes B1-B2 has been completed and 2018 the company invested in the first vertical painting line in Turkey, which has a Pinch valve and ensures stable paint thickness. In addition, as part of the completed press investments, the 10-inch SMS 4500 ton press and the 14-inch SMS 6600 ton press will be put into operation in 2025, and the A2 fireproof composite panel line will be put into operation in 2024. Our company, which currently has a modern foundry with a capacity of 11,000 tons/month, is able to meet all customer requirements in the field of aluminum profiles. In our facility, which operates on an area of 85,000 m², 70,000 m² are covered. Almost all production steps are controlled fully automatically. Ulusan Aluminium is the largest manufacturer in anatolia and trying to be one of the best companies in turkey and europe in the field of manufacturing aluminium. Ulusan company will continue to invest in the developing our work and will always try to follow the latest developments in this sector.

معلومات عنا

تأسست شركة الوسان في عام 1983. كانت في البداية يتعامل بتركيب أبواب والشبابيك ثم في عام 1990 بدأت بيع مقاطع ألومنيوم والاكسسوارات وبعدها في عام 1998 بدأت الخطوة الأولى في التصنيع حيث تم انشاء أول مصنع الدهان الإلكترونياتيك أو الدهان المشحون كهربائياً في العام 2007 بفضل الخبرة التي تمتد 24 عام في بيع ألومنيوم واكسسواراته وهي من أكبر (SMS) بدأت في تأسيس أول خط سحب ألومنيوم من نوع الشركات الألمانية بسعة 1750 طن مقاس 7 إنش. وفي عام 2011 تم افتتاح خط إنتاج بسعة إنتاجية 2000 طن مقاس 7 إنش (SMS) أيضاً مع نفس الشركة بسعة 2000 طن 7 إنش. وبعدها تم تركيب (SMS) ثم في عام 2015 تمت خط إنتاج B1 – B2 خط إنتاج الكومبوسيت بانل أو الكلابدينج من فئة ثم في عام 2018 أسست خط الدهان العامودي الأول من نوعه في تركيا حيث على تحديد سماكة الدهان على مقاطع (Pinch Valve System) بتقنية الألومنيوم. ولاحقاً أسست خط الأكسدة الكهربائية المؤتمتة باستطاعة 135000 أمبير وذلك لتلبية كافة متطلبات زبائننا من هذه الألوان عملية الإنتاج تتم بالماكينات بشكل كامل دون تدخل العامل البشري. بالإضافة إلى ذلك، ضمن (SMS) نطاق استثمارات المكبس المكتملة، سيتم في عام 2025 تشغيل مكبس 135000 طن مقاس 14 إنش، وسيتم تشغيل (SMS) 45000 طن مقاس 10 إنش ومكبس في عام 2024 A2 خط إنتاج الألواح ألومنيوم أو الكلابدينج مقاومة للحريق. وحالياً نخدم بمؤسسة مسبك حديثة بسعة 11000 طن / شهر والمصنع يغطي مساحة تقدر 85000 متر مربع والمساحة المغلقة أكثر من 70000 متر مربع.

قد حصل المصنع على خبرة كبيرة وسمعة طيبة وأصبح من أكبر المصانع الفاعلة في تركيا وأوروبا. ونحن في مصنع الوسان للألمنيوم نستثمر في تطوير عملنا ونسعى دائماً لمواكبة التطورات في مجالنا لتكون دائماً في المقدمة.

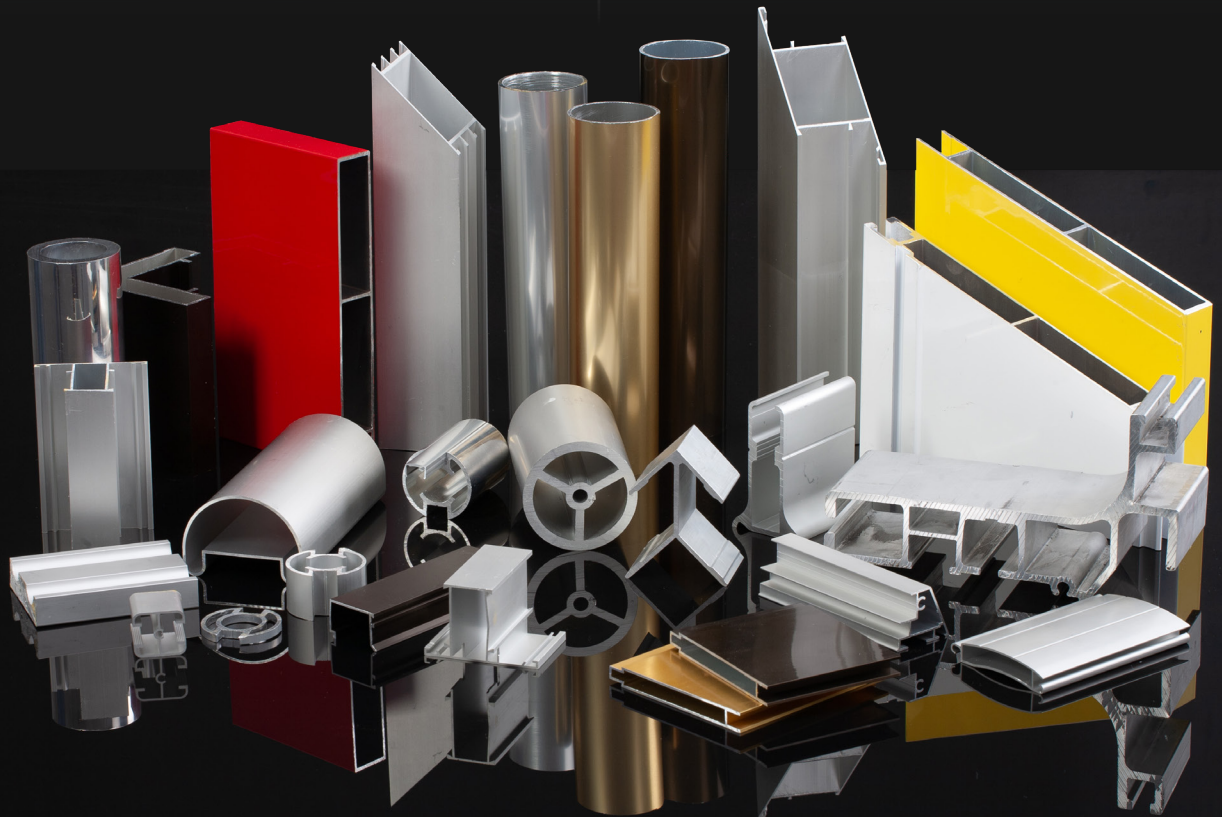

AF 50 ARWİS CEPHE SİSTEMİ ARWIS FACADE SYSTEM	04	27	AK 81 ARWİS ÇELİK KAPI KASASI SİSTEMİ ARWIS STEEL DOORCASE SYSTEM
AF 50 ARWİS CEPHE SİSTEMİ ARWIS FACADE SYSTEM	06	28	AG 40 MİNERVA LUKS CAM BALKON SİSTEMİ MİNERVA LUXURY BALCONY GLAZING SYSTEM
EF 50 ARWİS EKO CEPHE SİSTEMİ ARWIS ECONOMIC FACADE SYSTEM	08	29	AG 40 40 MİNERVA GOLD CAM BALKON SİSTEMİ MİNERVA GOLD BALCONY GLAZING SYSTEM
AF 65 ARWİS EKO CEPHE SİSTEMİ ARWIS ECONOMIC FACADE SYSTEM	10	30	AGT 40 MİNERVA ISI CAMLI CAM BALKON SİSTEMİ MİNERVA INSULATED BALCONY GLAZING SYSTEM
INV 128 ARWİS İNOVA SÜRME SİSTEMİ ARWIS INOVA SLIDING SYSTEM	12	32	SGS 95 ARWİS YALITIMSIZ SÜRME SİSTEMİ ARWIS UNINSULATED SLIDING SYSTEM
HB 126 ARWİS KALDIR SÜR SÜRME SİSTEMİ ARWIS LIFT and SLIDE SYSTEM	14	33	SGT 95 ARWİS YALITIMSIZ SÜRME SİSTEMİ ARWIS UNINSULATED SLIDING SYSTEM
AST 100 ARWİS YALITIMLI SÜRME SİSTEMİ ARWIS INSULATED SLIDING SYSTEM	16	34	AGT 95 ARWİS GİYOTİN SİSTEMİ ARWIS GUILLOTINE SYSTEM
AST 90 ARWİS YALITIMLI SÜRME SİSTEMİ ARWIS INSULATED SLIDING SYSTEM	17	35	APL 140 ARWİS PERGOLA SİSTEMİ ARWIS PERGOLA SYSTEM
AS 90 ARWİS YALITIMSIZ SÜRME SİSTEMİ ARWIS UNINSULATED SLIDING SYSTEM	18	36	KOMPOZİT PANEL COMPOSITE PANEL
AS 45 ARWİS YALITIMSIZ SÜRME SİSTEMİ ARWIS UNINSULATED SLIDING SYSTEM	19	38	YUVARLAK KÜPEŞTE ROUND HANDRAIL
AWT 55-58-64-73-77 ARWİS YALITIMLI SİSTEM SERİSİ ARWIS INSULATED SYSTEM SERIES	20	39	KARE KÜPEŞTE SQUARE HANDRAIL
AWT 40-50-55 ARWİS YALITIMSIZ SİSTEM SERİSİ ARWIS UNINSULATED SYSTEM SERIES	22	40	OVAL KÜPEŞTE OVAL HANDRAIL
AC 70 TERRA COTTA CEPHE SİSTEMİ TERRA COTTA FACADE SYSTEM	24	41	BAZA KÜPEŞTE BASE SYSTEMS
OCS 90 ARWİS OFİS BÖLME SİSTEMİ ARWIS OFFICE DIVIDING SYSTEM	25	42	LAMA KÜPEŞTE SHEET BEAM SYSTEMS
AK 65 ARWİS AYARLI KAPI KASASI SİSTEMİ ARWIS ADJUSTABLE DOORCASE SYSTEM	26	44	AD ARWİS DORSE SİSTEMİ ARWIS SEMI-TRAILER SYSTEM





**AF
50**
SİLİKONLU

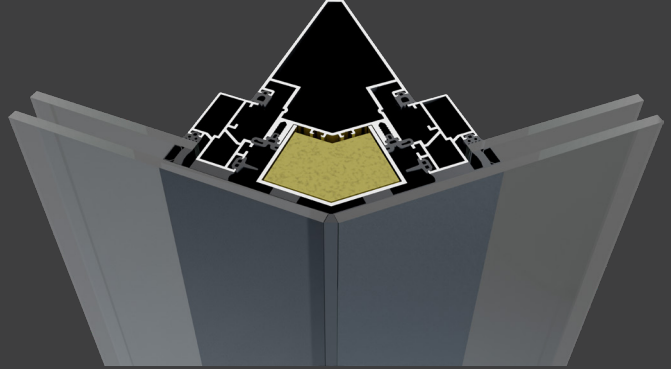
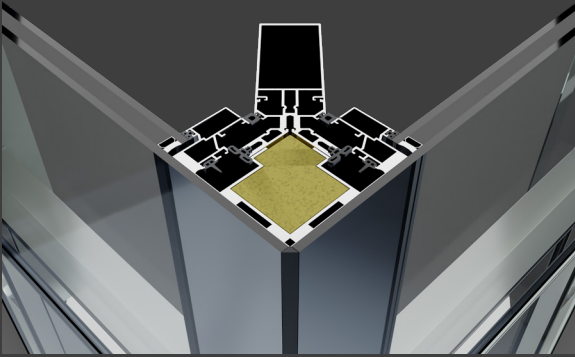

ÖZELLİKLER

- ▶ 50mm kalınlığında yatay ve düşey kayıt profilleri Yüksek rüzgar yükleri için tasarlanmış çok sayıda dikme profili
- ▶ Cam cama alüminyum silikonlu cephe uygulama imkanı
- ▶ Cephe içinde doğrama sistemleri uygulama imkanı
- ▶ AWT-58 sisteminden her tipte kapıyı cephe içine uygulama imkanı
- ▶ 2mm ve 1.6mm et kalınlığına sahip profiller
- ▶ Tüm Ral renklerinde ve eloksal seçeneklerinde QUALANOD ve QUALICOAT belgeli profil üretimi
- ▶ EPDM hava, toz ve su sızdırmazlık fitilleri

FEATURES

- ▶ Horizontal and vertical body profiles of 50 mm thickness
- ▶ A wide variety of strut profiles designed for high wind loads Possibility to apply aluminum silicon facade glass to glass
- ▶ Possibility to apply joinery systems in the facade
- ▶ Possibility to install all types of doors from the AWT- 58 system into the facade
- ▶ Profiles with 2 mm and 1.6 mm wall thickness Production of QUALANOD and QUALICOAT certified profiles in all RAL colors and anodised options
- ▶ EPDM wicks for air, dust and water proofing

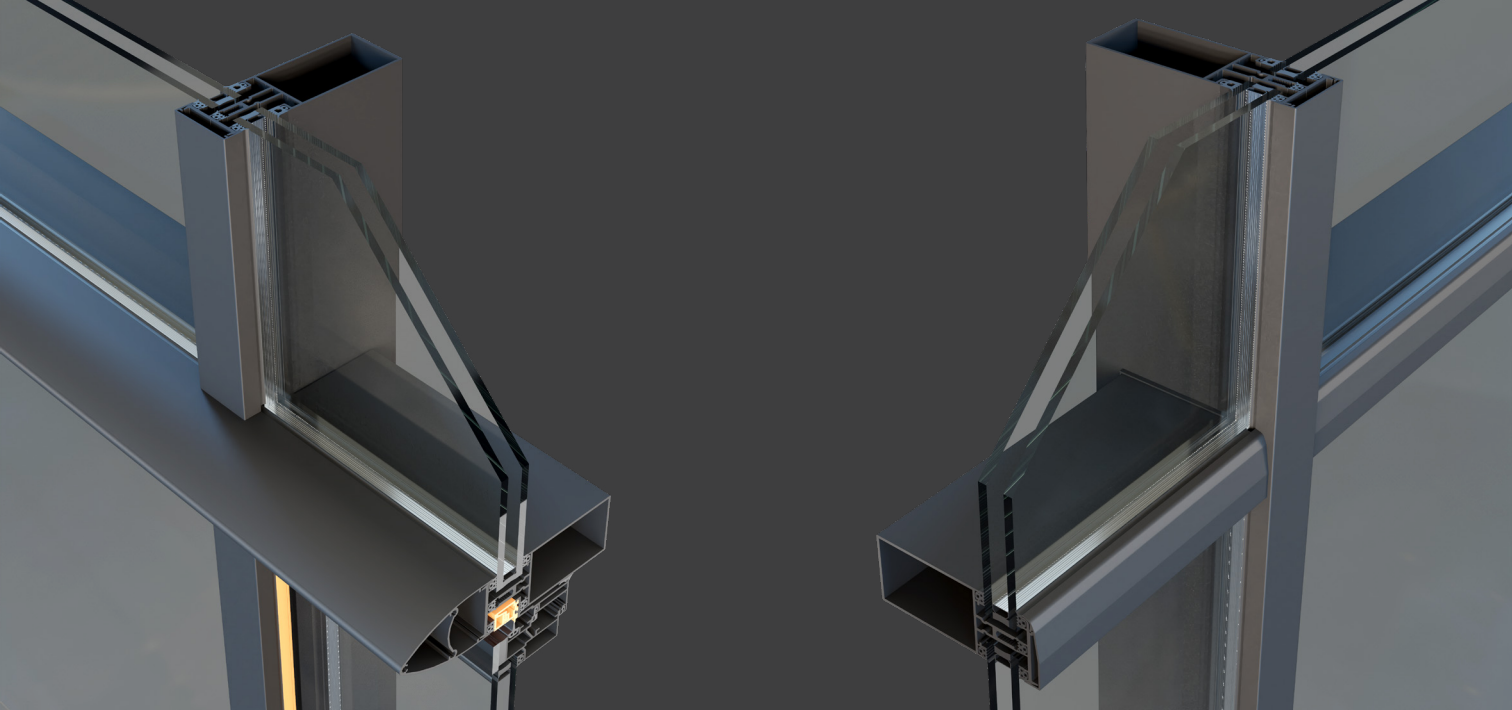
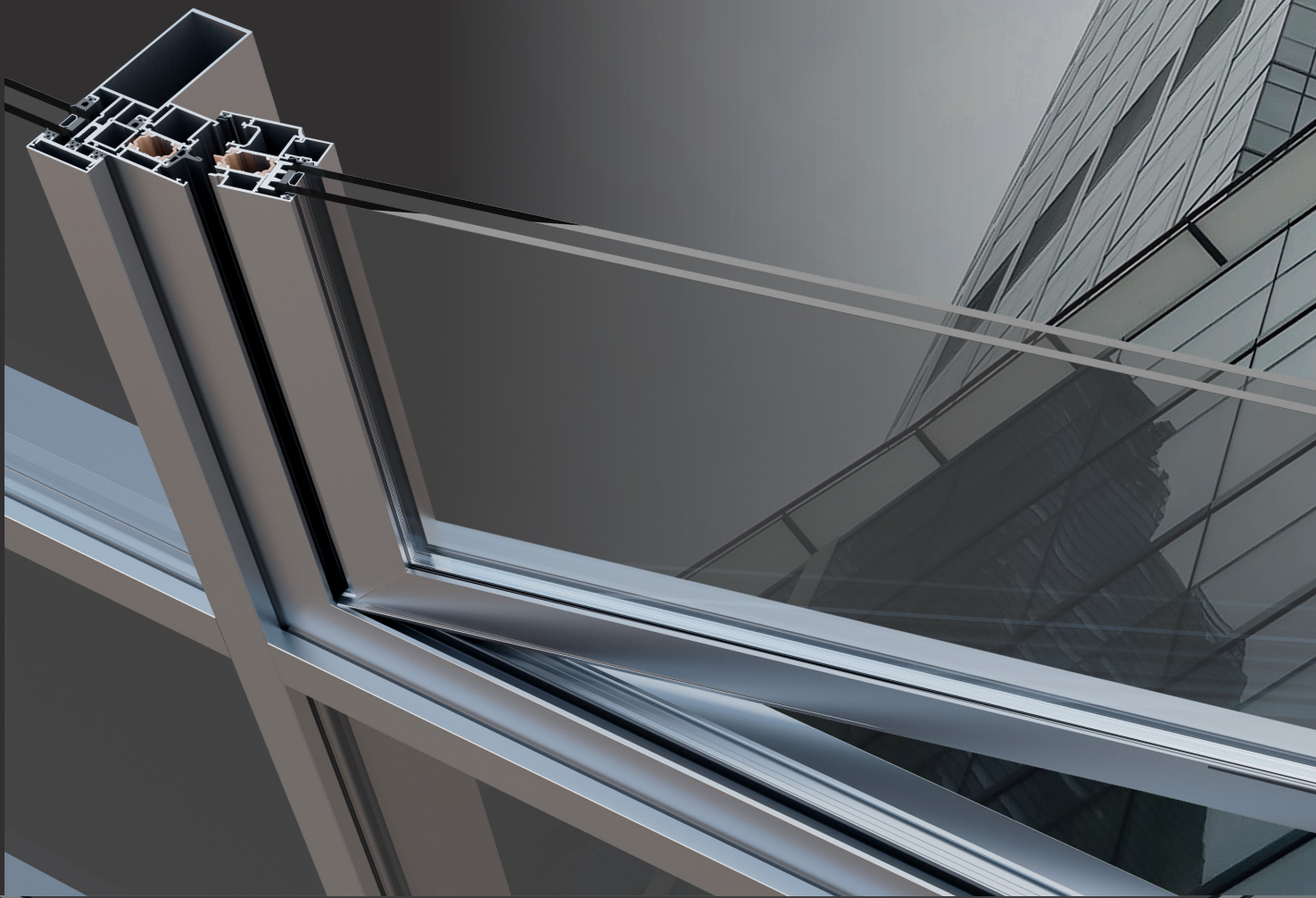



**AF
50
KAPAKLI**

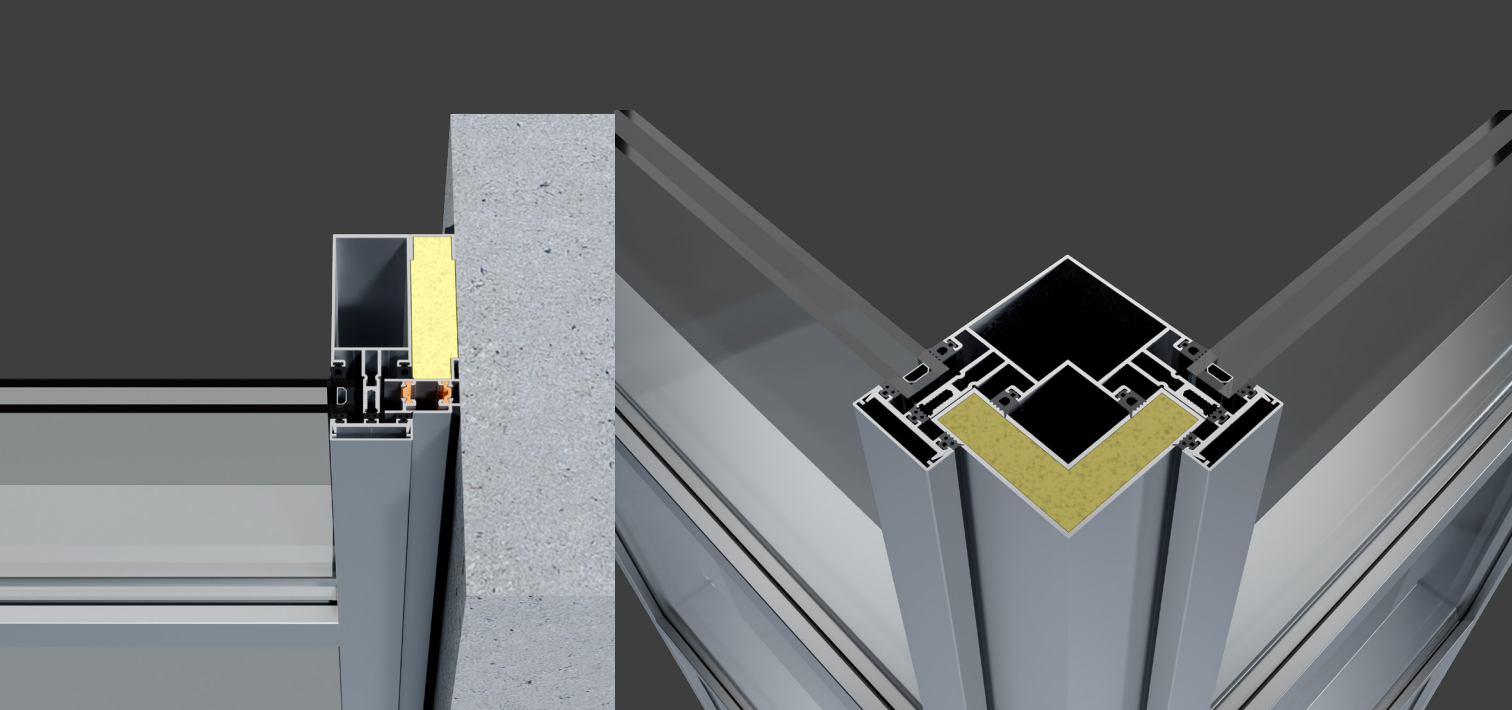

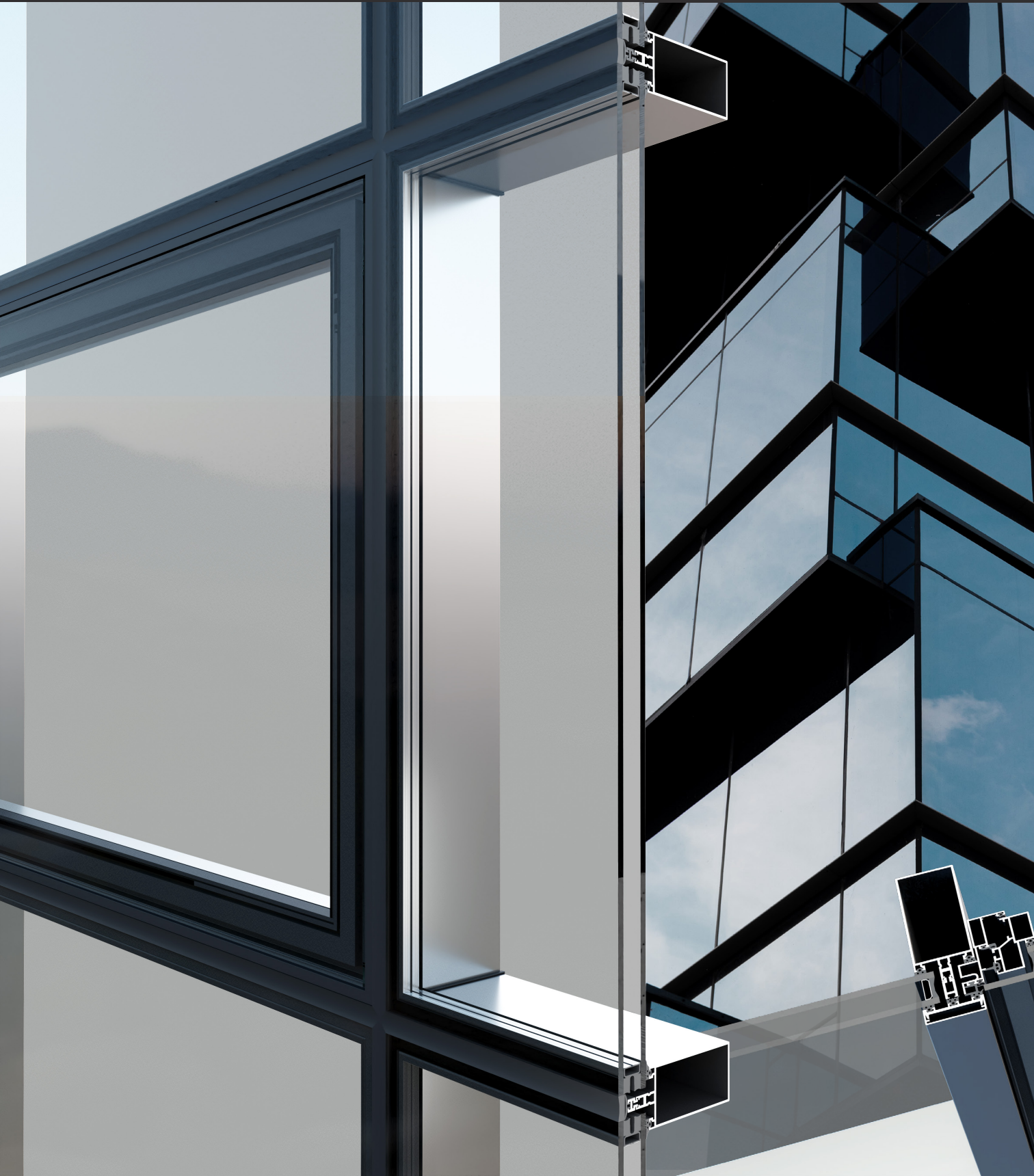



EF
50

ÖZELLİKLER

- ▶ 50 mm gövde genişliği
- ▶ 1.6mm et kalınlığına sahip alüminyum profiller
- ▶ Dikey ve yatayda tek tip profil kullanma imkanı
- ▶ Düşük maliyetli cephe uygulama imkanı
- ▶ Tüm Ral renklerinde ve eloksal seçeneklerinde QUALANOD ve QUALICOAT belgeli profil üretimi
- ▶ EPDM hava, su ve toz sızdırmazlık fitilleri
- ▶ Ekonomik cephe sistemi ve kasesiz sistem

FEATURES

- ▶ 50 mm body width
- ▶ Aluminum profiles with 1.6mm wall thickness
- ▶ Possibility to use same profile vertically and horizontally
- ▶ Possibility of facade application with low cost
- ▶ Production of QUALANOD and QUALICOAT certified profiles in all RAL colors and anodised options
- ▶ EPDM wicks for air, dust and water proofing
- ▶ Economic facade system and cassetteless system.

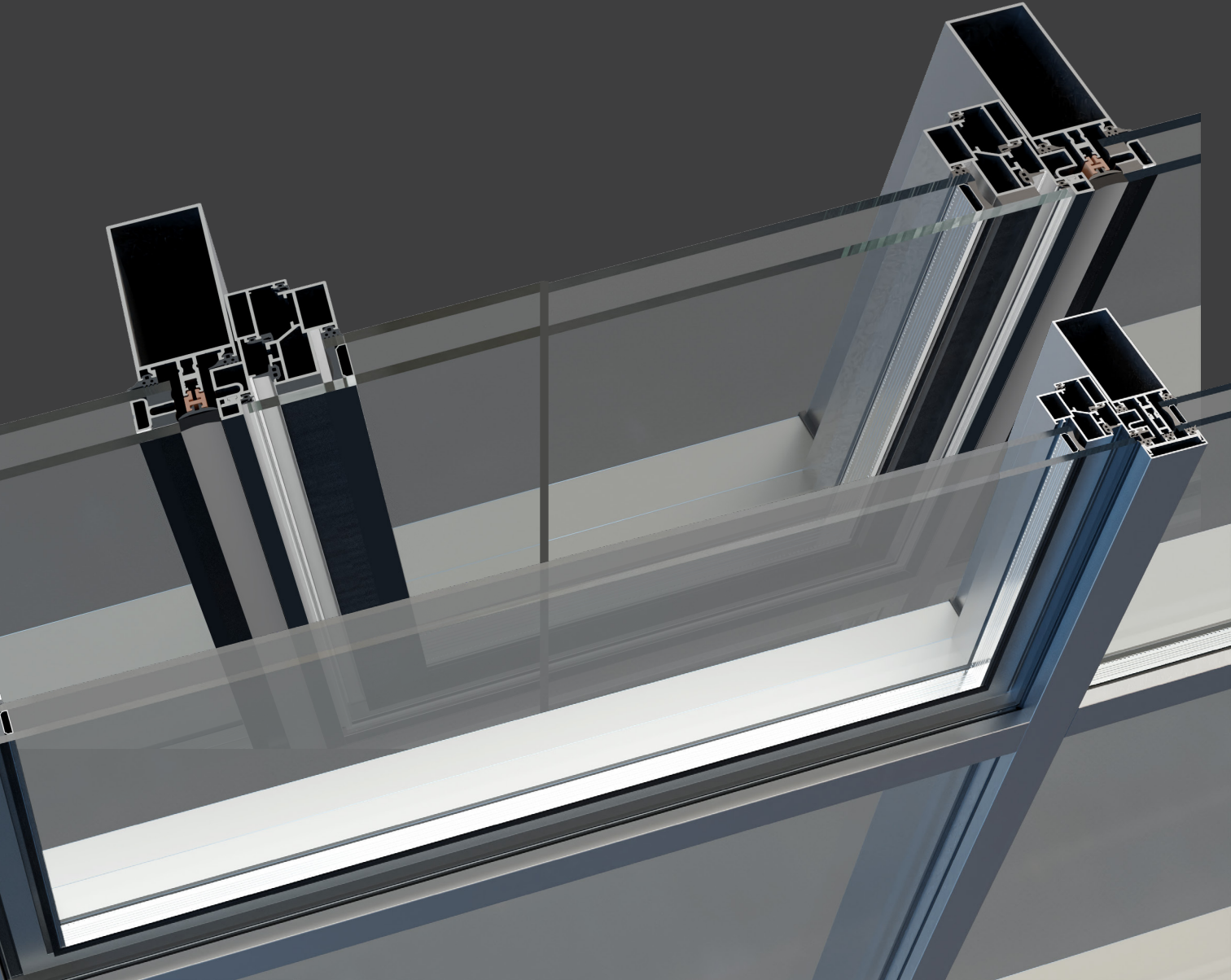





AF
65

ÖZELLİKLER

- ▶ Çelik takviyeli cephe sistemi
- ▶ 65 mm gövde genişliği geniş açıklıklar için ideal
- ▶ 2 mm et kalınlığına sahip alüminyum profiller
- ▶ Düşük maliyetli cephe uygulama imkanı
- ▶ Tüm Ral renklerinde ve eloksal seçeneklerinde QUALANOD ve QUALICOAT belgeli profil üretimi
- ▶ EPDM hava, su ve toz sızdırmazlık fitilleri

FEATURES

- ▶ Reinforced steel facade system
- ▶ Body width of 65 mm is ideal for wide openings
- ▶ Aluminum profiles with 2 mm wall thickness
- ▶ Low cost facade application possibility
- ▶ Production of QUALANOD and QUALICOAT certified profiles in all RAL colors and anodised options
- ▶ EPDM air, water and dust sealing wicks

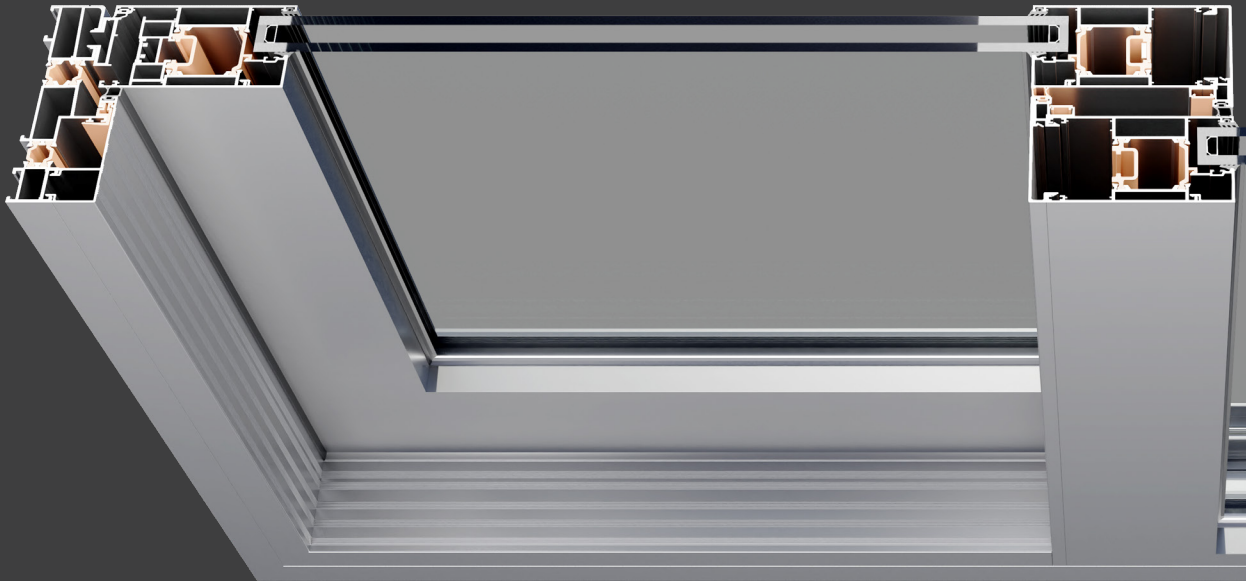
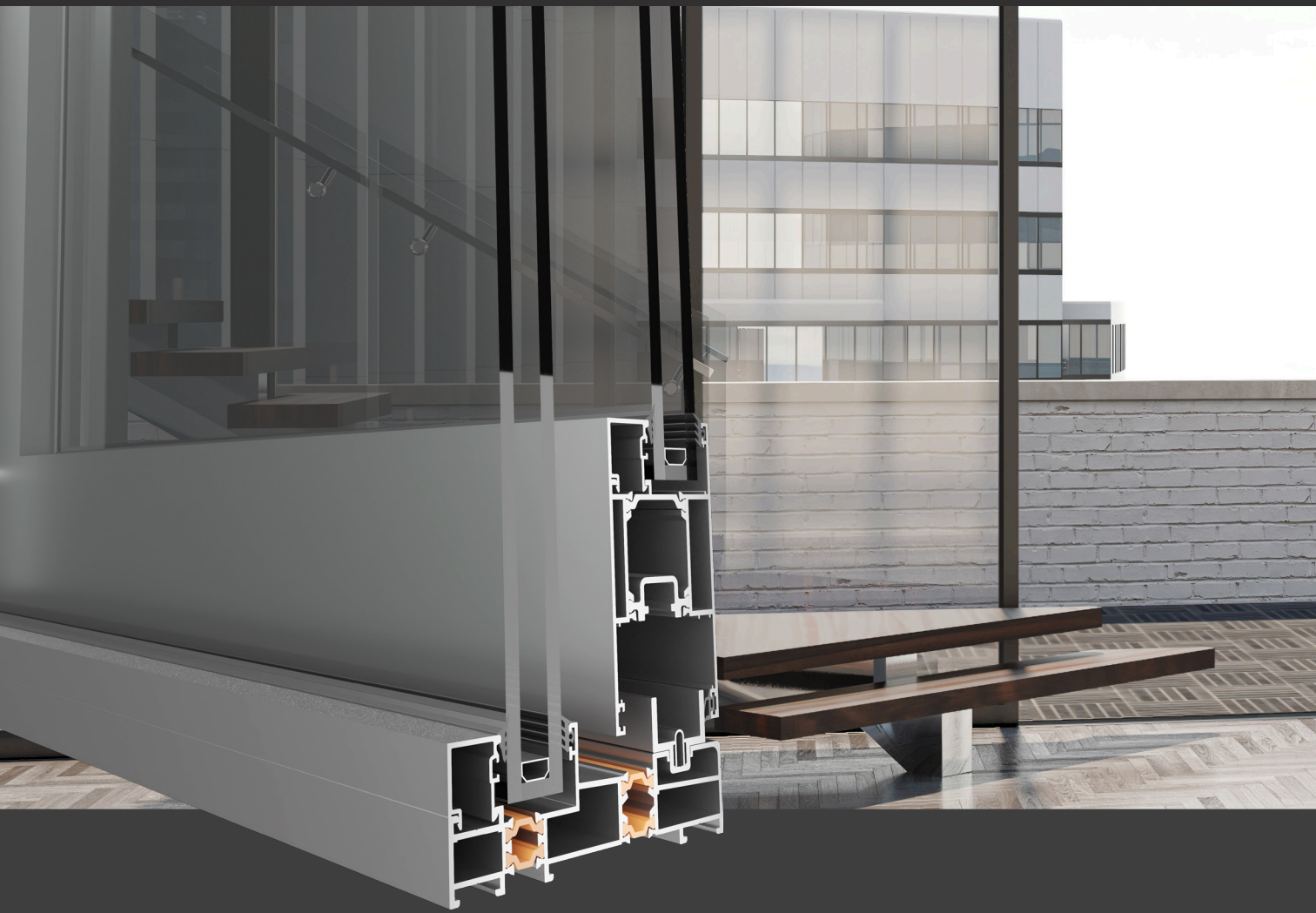



INV 128





HB 126

ÖZELLİKLER

- ▶ Yüksek ısı yalıtım
- ▶ Büyük açıklukları ideal bir şekilde kapatma
- ▶ 55mm kanat derinliği ·126mm kasa derinliği
- ▶ Değişken et kalınlıkları ile yüksek statik çözümler
- ▶ 2 raylı kasa ile tek kanat veya çift kanat yapabilmek
- ▶ 200 kg'lık ve 300 kg'lık taşıma kapasitesi

FEATURES

- ▶ High thermal insulation
- ▶ Closing large openings in best way
- ▶ 55mm wing depth
- ▶ 126mm case depth
- ▶ High static solutions with variable wall thicknesses
- ▶ Possibility to make single or double wing by using case profile with 2 rails
- ▶ The carrying capacity of 200 kg and 300 kg

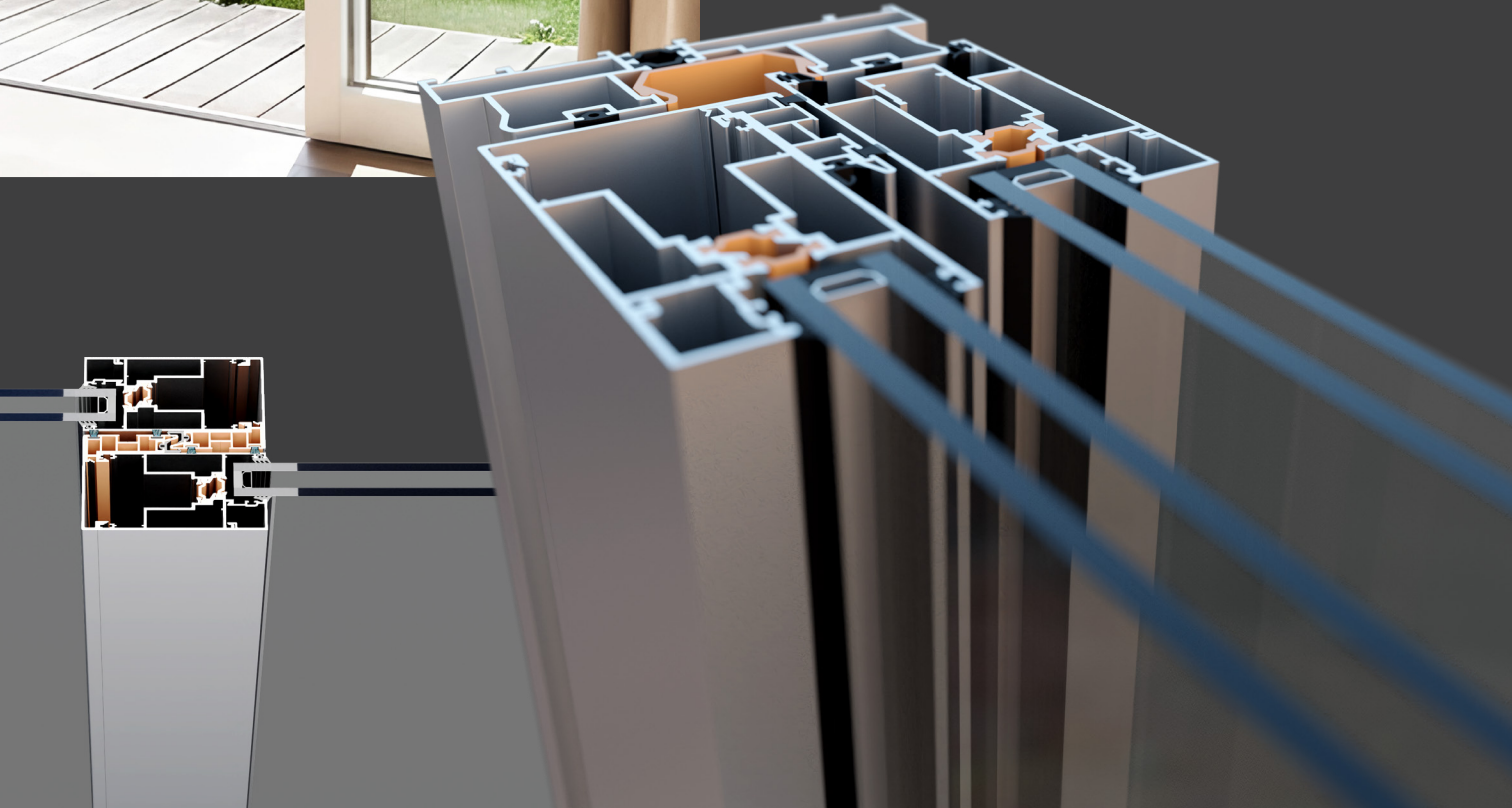



**AST
100**

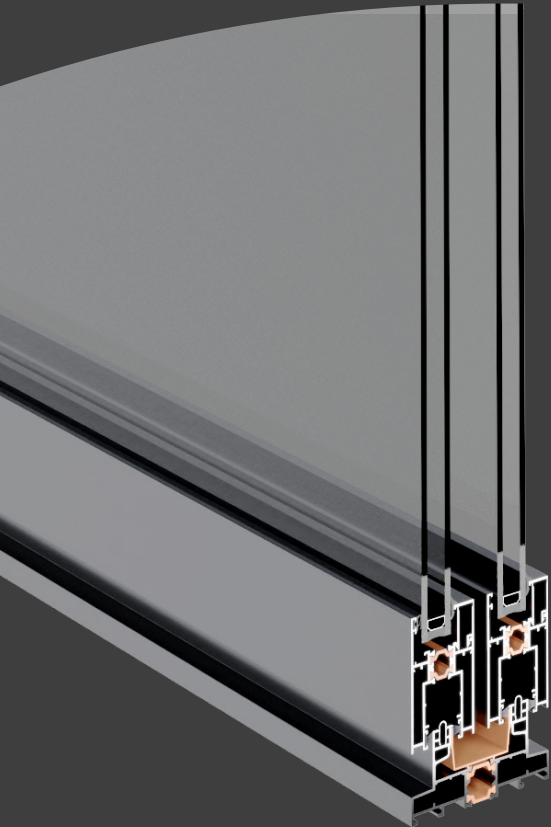
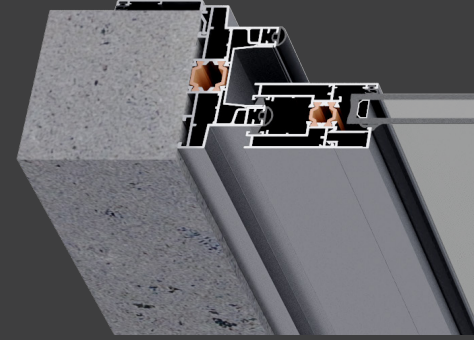
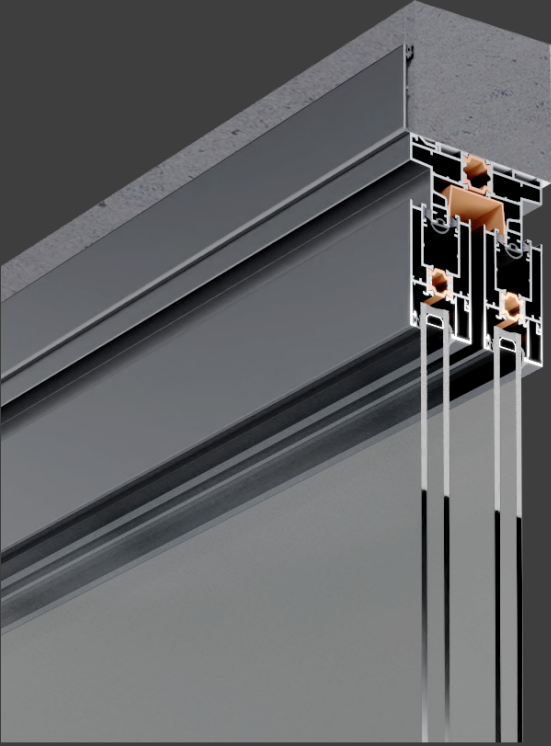

ÖZELLİKLER

- ▶ 100mm kasa derinliği
- ▶ 2 veya 3 raylı kasa kullanım olanağı
- ▶ Sürme doğrama üstü veya yanında sabit kullanım olanağı
- ▶ İthal ve yerli olmak üzere çok çeşitli aksesuar imkanı
- ▶ Sürtünmeyi azaltan özel rulmanlar sayesinde kolay kullanım imkanı
- ▶ Tüm sürme pozlarını uygulayabilme imkanı
- ▶ Krom saclar üzerinde yürüyen kanatlar
- ▶ Kolay su tahliye sistemi
- ▶ Yüksek ısı verimliliği performansı
- ▶ Tüm Ral renklerinde ve eloksal seçeneklerinde QUALANOD ve QUALICOAT belgeli profil üretimi

FEATURES

- ▶ 100 mm case depth
- ▶ Possibility to use case with 2 or 3 rails
- ▶ Possibility of fixed usage onto or next to sliding joinery
- ▶ A wide range of accessories including imported and domestic accessories
- ▶ Easy to use thanks to special bearings which reduce friction
- ▶ Ability to apply all sliding units
- ▶ Wings working on chrome sheets
- ▶ Easy water discharge system
- ▶ High thermal efficiency performance
- ▶ Production of QUALANOD and QUALICOAT certified profiles in all RAL colors and anodised options



AST 90

ÖZELLİKLER

- ▶ 90 mm kasa derinliği
- ▶ 2 veya 3 raylı kasa kullanım olanağı
- ▶ Sürme doğrama üstü veya yanında sabit kullanım olanağı
- ▶ Gönyeli veya etekli kanat kullanımı
- ▶ Tüm profillerde hem köşe presi hem de alıyanlı takoz kullanma imkanı
- ▶ İthal ve yerli olmak üzere çok çeşitli aksesuar imkanı
- ▶ Sürtünmeyi azaltan özel rulmanlar sayesinde kolay kullanım imkanı
- ▶ Tüm sürme pozlarını uygulayabilme imkanı
- ▶ Krom saclar üzerinde yürüyen kanatlar
- ▶ Kolay su tahliye sistemi - Yüksek ısı verimliliği performansı
- ▶ Tüm Ral renklerinde ve eloksal seçeneklerinde QUALANOD ve QUALICOAT belgeli profil üretimi

FEATURES

- ▶ 90 mm case depth
- ▶ Possibility to use case with 2 or 3 rails
- ▶ Possibility of fixed usage onto or next to sliding joinery
- ▶ Use of angled or skirted wing
- ▶ Possibility to use both corner presses and adjustable wedges in all profiles
- ▶ A wide range of accessories including imported and domestic accessories
- ▶ Easy to use thanks to special bearings to reduce friction
- ▶ Ability to apply all sliding units
- ▶ Wings working on chrome sheets
- ▶ Easy water discharge system
- ▶ High thermal efficiency performance
- ▶ Production of QUALANOD and QUALICOAT certified profiles in all RAL colors and anodised options



AS
90

ÖZELLİKLER

- ▶ 90 mm kasa derinliği
- ▶ 2 veya 3 raylı kasa kullanım olanağı
- ▶ Sürme doğrama üstü veya yanında sabit kullanım olanağı · Gönyeli veya etekli kanat kullanımı
- ▶ Tüm profillerde hem köşe presi hem de alınlı takoz kullanma imkanı
- ▶ İthal ve yerli olmak üzere çok çeşitli aksesuar imkanı
- ▶ Sürtünmeyi azaltan özel rulmanlar sayesinde kolay kullanım imkanı
- ▶ Tüm sürme pozlarını uygulayabilme imkanı
- ▶ Krom saclar üzerinde yürüyen kanatlar
- ▶ Kolay su tahliye sistemi
- ▶ Tüm Ral renklerinde ve eloksal seçeneklerinde QUALANOD ve QUALICOAT belgeli profil üretimi

FEATURES

- ▶ 90 mm case depth
- ▶ Possibility to use 2 or 3 rails
- ▶ Possibility of fixed usage onto or next to sliding joinery
- ▶ Use of angled or skirted wing
- ▶ Possibility to use both corner presses and adjustable wedges in all profiles
- ▶ A wide range of accessories including imported and domestic accessories
- ▶ Easy to use thanks to special bearings to reduce friction
- ▶ Ability to apply all sliding units
- ▶ Wings working on chrome sheets
- ▶ Easy water discharge system
- ▶ Production of QUALANOD and QUALICOAT certified profiles in all RAL colors and anodised options





AS
45



ÖZELLİKLER

- ▶ 45 mm kasa derinliği
- ▶ Sürme doğrama üstü veya yanında sabit kullanım olanağı
- ▶ Tüm profillerde alyanlı takoz kullanma imkanı
- ▶ İthal ve yerli olmak üzere çok çeşitli aksesuar imkanı
- ▶ Sürtünmeyi azaltan özel rulmanlar sayesinde kolay kullanım imkanı
- ▶ Tüm sürme pozlarını uygulayabilme imkanı
- ▶ Kolay su tahliye sistemi
- ▶ Tüm Ral renklerinde ve eloksal seçeneklerinde QUALANOD ve QUALICOAT belgeli profil üretimi
- ▶ Düşük maliyetli sürme uygulama imkanı

FEATURES

- ▶ 45 mm case depth
- ▶ Possibility of fixed usage onto or next to sliding joinery
- ▶ Possibility to use same wedges in all profiles
- ▶ A wide range of accessories including imported and domestic accessories
- ▶ Easy to use thanks to special bearings to reduce friction
- ▶ Ability to apply all sliding units
- ▶ Easy water discharge system
- ▶ Production of QUALANOD and QUALICOAT certified profiles in all RAL colors and anodised options
- ▶ Low-cost sliding application possibility

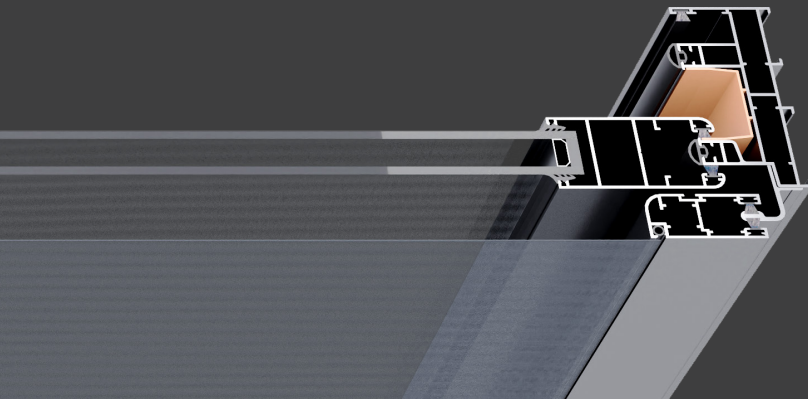

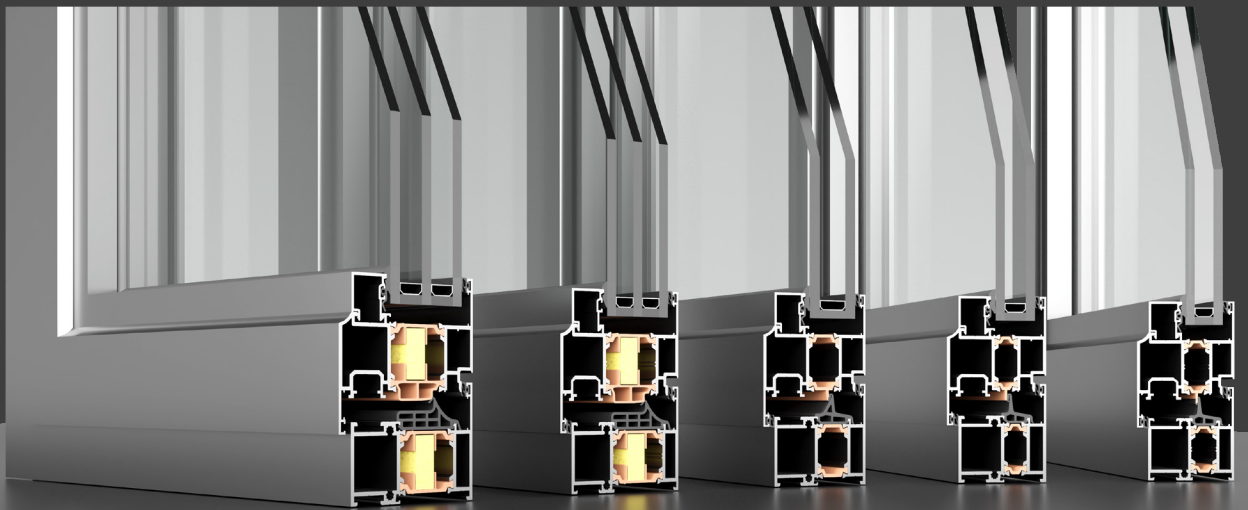
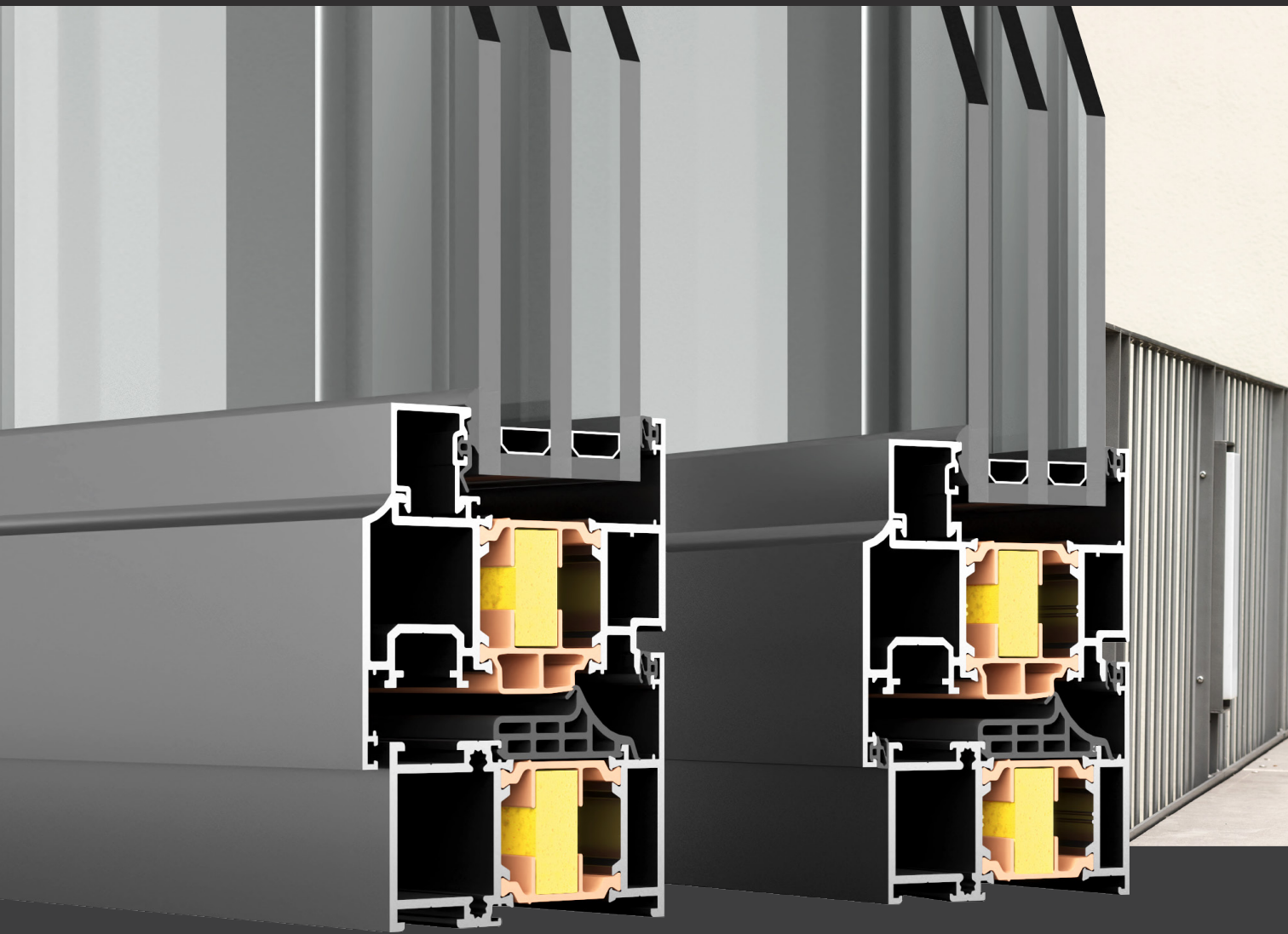



AWT
55 - 58 - 64
73 - 77



ÖZELLİKLER

- ▶ Awt 55-58-64-73-77 her tip yalıtımlı kapı ,pencere ihtiyacını karşılayan komple bir sistemdir.
- ▶ Sistem derinlikleri 62,5/65,5/71,5 mm dir.
- ▶ Profiller arasında 16 mm/14,8 mm/21mm lik ısı bariyerleri kullanılmıştır.
- ▶ Sistem içinde profil çeşitliliği zengin olan Awt 55-58-64-73-77 birçok dizayn seçeneği sunar.
- ▶ Giriş kapıları, düşey-yatay pencereler gibi çok varyasyonlu birçok mimari talebe cevap verir.
- ▶ Tüm profillerin 1,4 mm ve 2mm et kalınlığı çeşitleri mevcuttur.
- ▶ Tüm eloksal seçeneklerinde ve ral renklerinde Qualicoat ve Qualanod belgeli profil üretimi.
- ▶ Tüm sistem profillerinde DIN 12020-2 standartlarında üretim
- ▶ Epdm hava su ve toz sızdırmazlık fitilleri
- ▶ Başarı ile tanımlanan IFT performans testleri

FEATURES

- ▶ Awt 55-58-64-73-77 is a complete system that meets all types of insulated doors, windows.
- ▶ System depth is 62,5/65,5/71,5 mm
- ▶ 21 mm thermal barriers are used between the profiles
- ▶ Awt 55-58-64-73-77 offers a wide range of design options.
- ▶ It responds to many multi-variant architectural requests such as entrance gates, vertical-horizontal windows
- ▶ All profile types are available in 1.4 mm and 2 mm wall thickness
- ▶ Qualicoat and Qualanod certified profile production in all anodized options and ral colors
- ▶ Production in DIN 12020-2 standards for all system profiles
- ▶ Epdm air, water and dust sealing wicks
- ▶ Success-defined IFT performance tests

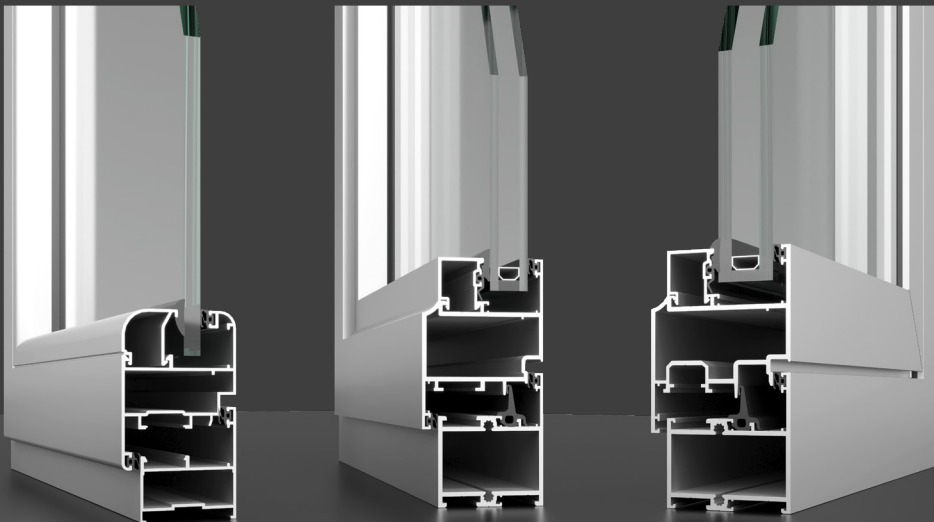
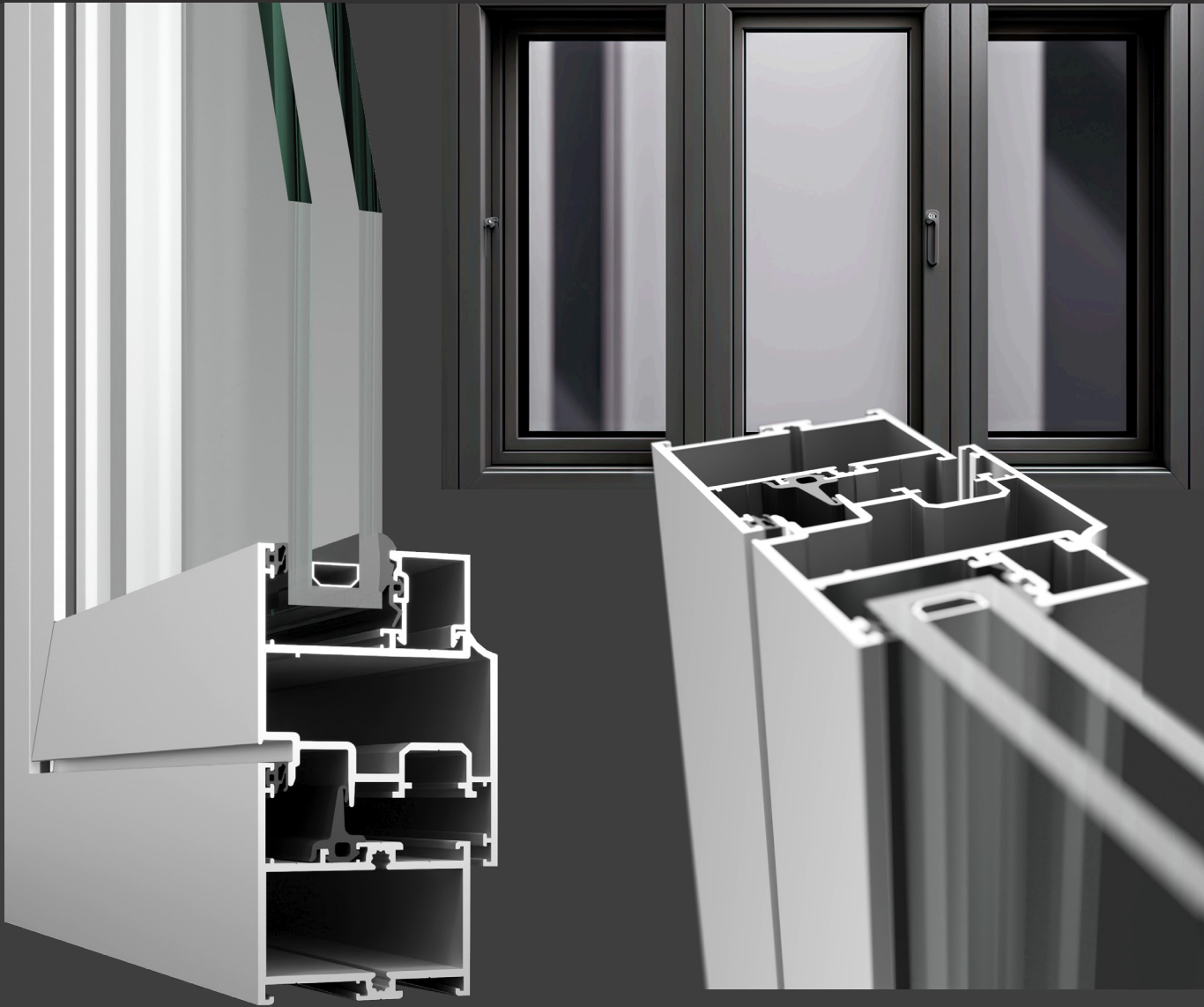



AWT 40 - 50 - 55



ÖZELLİKLER

- ▶ Aw 40-50-55 her tip yalıtımsız kapı pencere ihtiyacını karşılayan komple bir sistemdir.
- ▶ Sistem derinliği 47,5 mm/57,5 mm/62,5 mm dir.
- ▶ Sistem içinde profil çeşitliliği zengin olan Aw 40-50-55 pek çok sistem ile bütünlük sağlar.
- ▶ Aw 40-50-55 sistemi çok varyasyonlu olup birçok mimari talebe cevap verir.
- ▶ Tüm profillerin 1,4 mm ve 2 mm et kalınlığı çeşitleri mevcuttur.
- ▶ Tüm eloksal seçeneklerinde ve ral renklerinde Qualicoat ve Qualonod belgeli profil üretimi
- ▶ Tüm sistem profillerinde DIN 12020-2 standartlarında üretim
- ▶ Epdm fitillerle hava, su ve toz sızdırmazlık

FEATURES

- ▶ Aw 40-50-55 is a complete system that meets all kinds of uninsulated doors and windows
- ▶ System depth is 47,5 mm/57,5 mm/62,5 mm
- ▶ The Aw 40-50-55, which has a rich profile variety in the system, is integrated with many systems
- ▶ The Aw 40-50-55 System is multivariate and responds to many architectural requests.
- ▶ All profile types are available in 1.4 mm and 2 mm wall thickness
- ▶ Qualicoat and Qualonod certified profile production in all anodized and ral colors
- ▶ Production in DIN 12020-2 standards for all system profiles
- ▶ Epdm air, water and dust sealing wicks



AC
70



ÖZELLİKLER

- ▶ Kiremit renginde ve ya ahşap görünümünde profil üretme imkanı
- ▶ Pişmiş kil malzemelere göre daha hafif cephe kaplamaları
- ▶ Ucuz maliyet yükü
- ▶ Pratikliği ile zamandan kazanım
- ▶ Dikeyde ve yatayda ki derzleri ile şık bir görünüm
- ▶ Tüm Ral renklerinde ve eloksal seçeneklerinde QUALANOD ve QUALICOAT belgeli profil üretimi
- ▶ EPDM hava, su ve toz sızdırmazlık fitilleri

FEATURES

- ▶ Possibility to produce profile in brick-color or wooden look
- ▶ Lighter facade covering than baked clay materials
- ▶ Cheap cost
- ▶ Practicality and time-saving
- ▶ Stylish appearance with joints on the surface and on the horizon
- ▶ Production of QUALANOD and QUALICOAT certified profiles in all Ral colors and anodized options
- ▶ EPDM air, water and dust sealing wicks



ÖZELLİKLER

- ▶ OCS-90 çok yönlü kullanıma uygun bir iç bölme sistemidir.
- ▶ İç veya dış mekanlarda kullanılacak cam bölmeler için tasarlanmış eloksallı veya boyalı dikmeleri bağlantı parçaları ile sabitlenen bir sistemdir.
- ▶ İstenirse alüminyum çerçeveye monte edilmiş cam panellerin dikmelerle ve yatay kayıtlarla her iki taraftan asılmasıyla oluşturulan içerden ve dışardan bakıldığında sadece cam yüzeyi ve cam panel aralarında estetik bir derz boşluğu görünen sistemdir
- ▶ Çok ince görümlü alüminyum şerit ile çerçevelenmiş cam paneller.
- ▶ Alüminyumun hiç görünmediği cam paneller
- ▶ Hem ahşap hem alüminyum kapı uygulama imkanı
- ▶ Her çeşit geometrik şekilde üretim imkanı
- ▶ Cam aralarına jaluzi sistemi monte etme imkanı

FEATURES

- ▶ OCS-90 is an internal compartment system that is suitable for multipurpose.
- ▶ It is a system the anodized or painted struts of which are designed for glass separation applied interior or exterior and are fixed with fixing apparatus
- ▶ It is a system that is formed by hanging the glass panels mounted to aluminium frame by means of vertical and horizontal aluminium profiles and when looked at from inside or outside, if desired, only glass panels and aesthetic gaps between panels are visible.
- ▶ Glass panels framed with aluminium strip that has very thin appearance
- ▶ Glass panels where any aluminium is not visible
- ▶ Possibility to apply both wooden and aluminium doors
- ▶ Possibility to produce all kinds of geometric shapes
- ▶ Possibility to install Blinds System between windows





**AK
65**



ÖZELLİKLER

- ▶ 150 mm başlayıp her duvar kalınlığına uygun gövde genişliği
- ▶ 1.6 mm et kalınlığına sahip alüminyum profiller
- ▶ Düşük maliyetli ve gösterişli kapı uygulama imkanı
- ▶ Ahşap, alüminyum doğrama veya alüminyum cam kapı yapma imkanı
- ▶ Tüm Ral renklerinde ve eloksal seçeneklerinde QUALANOD ve QUALICOAT belgeli profil üretimi
- ▶ EPDM hava, su ve toz sızdırmazlık fitilleri

FEATURES

- ▶ Body width starting from 150 mm and suitable for every wall thickness
- ▶ Aluminum profiles with 1.6 mm wall thickness
- ▶ Low cost and amazing door application possibility
- ▶ Possibility to make wooden, aluminum joinery or aluminum glass door
- ▶ Production of QUALANOD and QUALICOAT certified profiles in all RAL colors and anodised options
- ▶ EPDM air, water and dust sealing wicks



AK
81



ÖZELLİKLER

- ▶ 150 mm başlayıp her duvar kalınlığına uygun gövde genişliği
- ▶ 1.6 mm et kalınlığına sahip alüminyum profiller
- ▶ Düşük maliyetli ve gösterişli kapı uygulama imkanı
- ▶ Dışı alüminyum içi ahşap kapı yapma imkanı
- ▶ Ahşap veya alüminyum cam kapı yapma imkanı
- ▶ Çelik kapı sistemlerine uyumluluk
- ▶ Tüm Ral renklerinde ve eloksal seçeneklerinde QUALANOD ve QUALICOAT belgeli profil üretimi
- ▶ EPDM hava, su ve toz sızdırmazlık fitilleri

FEATURES

- ▶ Body width starting from 150 mm and suitable for every wall thickness
- ▶ Aluminum profiles with 1.6 mm wall thickness
- ▶ Low cost and amazing door application possibility
- ▶ Possibility to make the exterior side wooden and interior side aluminum
- ▶ Possibility to make wooden or aluminum glass door · Compatibility with steel door systems
- ▶ Production of QUALANOD and QUALICOAT certified profiles in all RAL colors and anodised options
- ▶ EPDM air, water and dust sealing wicks





**AG
40
MiNERVA**

ÖZELLİKLER

- ▶ Camlar sağa sola veya her iki yöne toplanabilir.
- ▶ Estetik tasarımları ile binanıza mimari değer katmaktadır.
- ▶ Darbelere karşı dayanıklı temperli cam uygulaması ile güvenli ve emniyetli bir sistemdir.
- ▶ Temperli cam olmasından nedeniyle camın kırılması durumunda küçük ve kesici olmayan parçalara ayrılarak insan sağlığını tehdit zarar vermemektedir.
- ▶ Cam balkon sistemlerimiz ses ve ısı yalıtımı sağlamaktadır.
- ▶ 8 mm temperli cam kullanılmaktadır.
- ▶ Zengin renk seçenekleri ile estetik bir görünüm sunmaktadır.
- ▶ Maksimum kanat (cam) yüksekliği : 2500mm
- ▶ Maksimum kanat (cam) genişliği : 650mm
- ▶ Maksimum kanat (cam) ağırlığı : 45kg

FEATURES

- ▶ Glass can be collected right or left or in both directions
- ▶ Adding architectural value to your building with aesthetic designs .
- ▶ It is a safe and durable system with the application of tempered glass resistant to strokes.
- ▶ Because it is tempered glass, if it breaks small and non-cutting parts do not harm human health.
- ▶ Our glass balcony systems provide sound and heat insulation.
- ▶ 8 mm tempered glass is used.
- ▶ It offers an esthetic appearance with rich color options.
- ▶ Maximum wing (glass) height: 2500mm
- ▶ Maximum wing (glass) width: 650mm
- ▶ Maximum wing (glass) weight: 45kg



**AG
40
GOLD**

ÖZELLİKLER

- ▶ Camlar sağa sola veya her iki yöne toplanabilir
- ▶ Estetik tasarımları ile binanıza mimari değer katmaktadır.
- ▶ Darbelere karşı dayanıklı temperli cam uygulaması ile güvenli ve emniyetli bir sistemdir.
- ▶ Temperli cam olmasından nedeniyle camın kırılması durumunda küçük ve kesici olmayan parçalara ayrılarak insan sağlığını tehdit zarar vermemektedir.
- ▶ Cam balkon sistemlerimiz ses ve ısı yalıtımı sağlamaktadır.
- ▶ 8 mm temperli cam kullanılmaktadır.
- ▶ Zengin renk seçenekleri ile estetik bir görünüm sunmaktadır.
- ▶ Maksimum kanat (cam) yüksekliği : 2500mm
- ▶ Maksimum kanat (cam) genişliği : 650mm
- ▶ Maksimum kanat (cam) ağırlığı : 45kg

FEATURES

- ▶ Glass can be collected right or left or in both directions
- ▶ Adding architectural value to your building with aesthetic designs .
- ▶ It is a safe and durable system with the application of tempered glass resistant to strokes.
- ▶ Because it is tempered glass, if it breaks small and non-cutting parts do not harm human health.
- ▶ Our glass balcony systems provide sound and heat insulation.
- ▶ 8 mm tempered glass is used.
- ▶ It offers an esthetic appearance with rich color options.
- ▶ Maximum wing (glass) height: 2500mm
- ▶ Maximum wing (glass) width: 650mm
- ▶ Maximum wing (glass) weight: 45kg



**AGT
40**



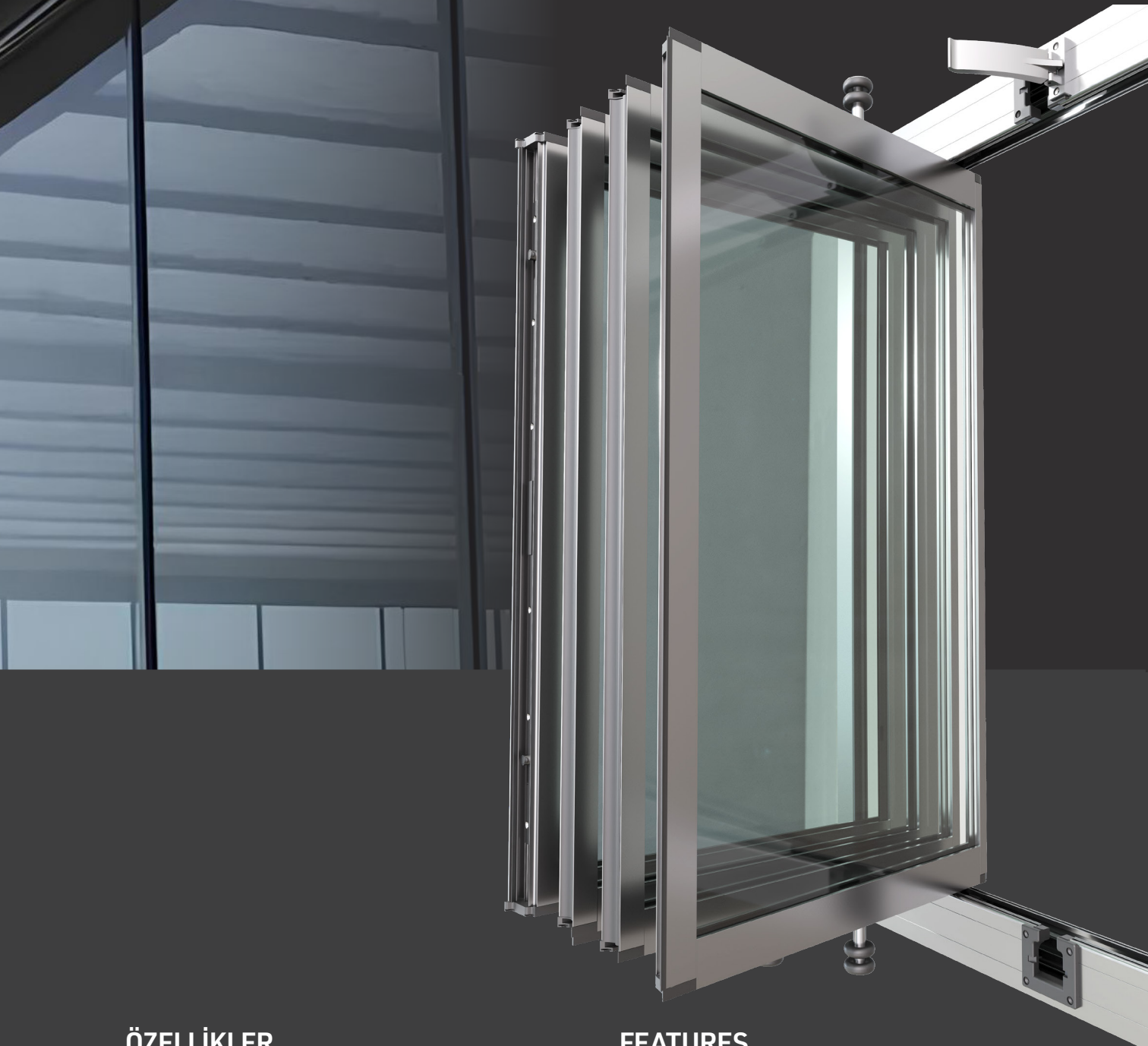

ÖZELLİKLER

- ▶ Katlanır ısıcamlı cam balkon sisteminde istenildiği kadar kanat sayısı uygulanabilir.
- ▶ İstenilen yöne açılım yapılabilir.
- ▶ Katlanır ısıcamlı cam balkon sisteminin teknik yapısı hem 4mm temperli cam +(20) +4mm temperli cam yada 6mm temperli cam +(16) +6mm temperli cam kullanımları için uygundur.
- ▶ Maksimum kanat (cam) yüksekliği : 2500mm
- ▶ Maksimum kanat (cam) genişliği : 650mm
- ▶ Maksimum kanat (cam) ağırlığı : 45kg

FEATURES

- ▶ In folding glass balcony system quantity wings can be applied as many as desired
- ▶ Can be opened in any direction
- ▶ The technical structure of the folding glass balcony system is suitable for both 4mm tempered glass +(20) +4mm tempered glass and 6mm tempered glass +(16) +6mm tempered glass.
- ▶ Maximum wing (glass) height: 2500mm
- ▶ Maximum wing (glass) width: 650mm
- ▶ Maximum wing (glass) weight: 45kg



**SGS
95**



ÖZELLİKLER

- ▶ Temperli özel camlar 8 mm veya 10 mm kalınlığında özel olarak kuvvetlendirilmiş yapıdadır.
- ▶ Maksimum yüksekliği 2,5 - 3 metre arasındadır. Kanat genişlikleri maksimum 2200 mm olarak kullanılır.
- ▶ Sistem kanatları alüminyuma özel contalar ile geçme olarak uygulanmaktadır.
- ▶ Kanatlarda yan kapaklara takılan kilitletler sayesinde tam bir güvenlik sağlamaktadır.
- ▶ Sistem her türlü terazisiz ortamda çalışmasının yanında alt tekerler kendi kendini teraziye almaktadır.

FEATURES

- ▶ Tempered special glasses are specially reinforced with a thickness of 8 mm or 10 mm.
- ▶ The maximum height is between 2.5 - 3 meters. Wing widths are used as maximum 2200 mm.
- ▶ The system wings are fitted with special aluminum gaskets.
- ▶ It provides complete security thanks to the locks on the side flaps in the wings.
- ▶ The system works in all kinds of unsteady environments and the lower wheels are selfbalancing.

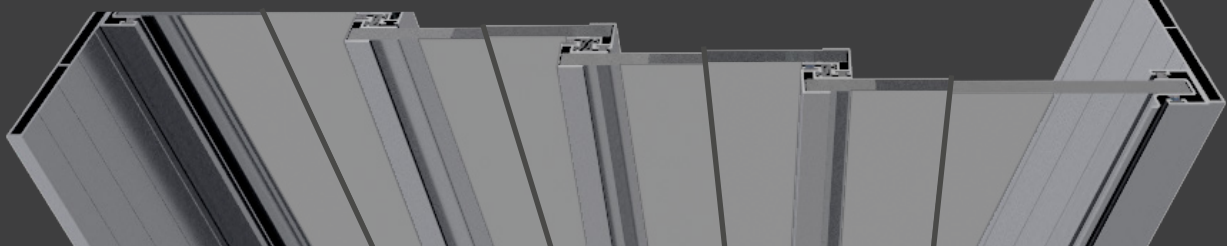



**SGT
95**

ÖZELLİKLER

- ▶ Isıcamlı sürme sisteminin teknik yapısı 5+(12)+5 MM Temperli cam kullanımları için uygundur.
- ▶ Maksimum yüksekliği 2,5 - 3 metre arasındadır. Kanat genişlikleri maksimum 1800 mm olarak kullanılır.
- ▶ Sistem kanatları alüminyuma özel contalar ile geçme olarak uygulanmaktadır.
- ▶ Kanatlarda yan kapaklara takılan kilitler sayesinde tam bir güvenlik sağlamaktadır.
- ▶ Sistem her türlü terazisiz ortamda çalışmasının yanında alt tekerler kendi kendini teraziye almaktadır.

FEATURES

- ▶ Technical structure of the insulating glass sliding system 5+(12)+5 MM, Suitable for tempered glass uses.
- ▶ The maximum height is between 2.5 - 3 meters. Wing widths are used as maximum 1800 mm.
- ▶ The system wings are fitted with special aluminum gaskets.
- ▶ It provides complete security thanks to the locks on the side flaps in the wings.
- ▶ The system works in all kinds of unsteady environments and the lower wheels are self-balancing.



**AGT
95**



ÖZELLİKLER

- ▶ Cafe, restaurant ve kış bahçelerinde kullanılabilir.
- ▶ Açılış ve kapanış uzaktan kumanda yapılabilir
- ▶ Görüş alanı bozulmaz. • Hava akışı ile sınırlı değildir.
- ▶ Zaman ayarlı sistem yaşlı ve engelliler için çok uygundur.
- ▶ Yağmur ve rüzgara karşı tam koruma.
- ▶ Alüminyum profilleri, tüm renklerde elektro statik fırın boyalı.

FEATURES

- ▶ It can be used in cafes, restaurants and winter gardens.
- ▶ Opening and closing can be remote controlled
- ▶ The landscape does not worsen
- ▶ It is not limited with air flow.
- ▶ Time adjustable system is very suitable for the elderly and the disabled.
- ▶ Full protection against rain and wind.
- ▶ Aluminum profiles are electrostatic painted in all colors.



APL 140



ÖZELLİKLER

- ▶ Temperli özel camlar 8 mm veya 12 mm kalınlığında özel olarak kuvvetlendirilmiş yapıdadır.
- ▶ Maksimum yüksekliği 2,5 - 3 metre arasındadır. Kanat genişlikleri maksimum 1800 mm olarak kullanılır.
- ▶ Sistem kanatları alüminyuma özel contalar ile geçme olarak uygulanmaktadır.
- ▶ Cam veya polikarbonat levha kullanılabilir.
- ▶ Dışarıdan gelebilecek yağmur kar suyu gibi etkenler oluk profili ile tahliye edilir.

FEATURES

- ▶ Tempered special glasses are specially reinforced with a thickness of 8 mm or 10 mm.
- ▶ The maximum height is between 2.5 - 3 meters. Wing widths are used as maximum 1800 mm.
- ▶ The system wings are fitted with special aluminum gaskets.
- ▶ Glass or polycarbonate sheet can be used.
- ▶ Factors such as rain snow, water which may come from outside are evacuated by the gutter profile.





ÖZELLİKLER

- ▶ Ulusan tarafından önerilen alt kontsrüksiyon ve montaj detayları uygulandığı takdirde,
- ▶ Kompozit paneller
- ▶ Arwisbond 20 yıl
- ▶ Facebond 20 yıl
- ▶ Plusbond 15 yıl garantilidir.
- ▶ Ton farkını engellemek için bir defada siparis verilmesi önerilir.
- ▶ Lütfen kompozit panelleri ok yönünde kullanınız.

FEATURES

- ▶ If suggested sub construction and installation details are applied,
- ▶ Composite panels
- ▶ Arwisbond 20 years
- ▶ Facebond 20 years
- ▶ Plusbond 15 years are under guarantee.
- ▶ To ensure the color consistency, placing total requirement in one order is recommended.
- ▶ Please applicate all the panels the arrow direction.



**KOMPOZİT
PANEL**
COMPOSITE
PANEL

Kompozit Panel Ebatları / Panel Dimensions

Kompozit Panel Kalınlıkları
Thickness Of Composite Panel 3 mm - 4 mm - 5 mm - 6 mm

Maksimum Üretim Boyu
Maximum Production Length 10000 mm

Standart Üretim Ebatları
Standard Panel Dimensions 1250 mm x 3200 mm x 4 mm
1500 mm x 3200 mm x 4 mm

**Kullanılan Alüminyum Levhanın Mekanik Özellikleri /
Mechanical Properties Of Aluminium**

Çekme Mukavemeti (Rm)
Tensile Strength (Rm) 186 MPa (min 130 Mpa)

Akma Mukavemeti (Rp 0.2)
Yield Strength (Rp 0.2) 148 MPa (min 90 Mpa)

Yüzde Uzama (A50%)
Elongation 6.8 (min 5)

Elastikiyet Modülü
Modulus Of Elasticity 70000 MPa

Egiklik / Bow

Panel Boyu
Panel Length < 1500 mm max 5mm

Panel Boyu
Panel Length 1500 mm - 3000 mm max 7 mm

Panel Boyu
Panel Length < 3000 mm max 10 mm

Üretim Toleransları / Tolerances

Kompozit Panel Kalınlığı
Thickness Of Composite Panel ± 0.2 mm

Kompozit Panel Genisliği
Width Of Composite Panel ± 2.0 mm

Kompozit Panel Boyu
Length Of Composite Panel ± 4.0 mm

Diyagonal Fark
Diogonal Difference max 3.0 mm

Doğrusallık (Ende Ve Boyda)
Linearity (On Width And Length) ± 0.2 mm

Uzama Miktarı (A%50)
Elongation 1.2 mm/m (50° C)



**YUVARLAK
KÜPEŞTE**
ROUND
HANDRAIL



ÖZELLİKLER

- ▶ Merdiven, balkon, teras ve havuz kenarları gibi kullanım alanlarına estetik, görsellik ve uzun ömürlülük sağlayarak yapılarınıza değer katar.
- ▶ Malzemelerin temizlik dışında hiçbir bakım gerektirmez
- ▶ Uzun yıllar sorunsuz kullanım imkânı sağlar
- ▶ Paslanmaz ve korozyona dayanıklıdır.
- ▶ Sağlam ve hafif olması ile yapılarınızın mimari açıdan yük teşkil etemez
- ▶ Hem iç, hem de dış mekânlarda rahatlıkla kullanılabilir.

FEATURES

- ▶ Adding value to your buildings by providing aesthetics, visibility and longevity to usage areas such as stairs, balconies, terraces and pool sides.
- ▶ Materials do not require any maintenance other than cleaning
- ▶ Provides unproblematic usage for many years
- ▶ It is stainless and corrosion resistant.
- ▶ Because of its durability and lightweight it does not be a burden to your building
- ▶ Can be used easily both inside and outside.



**KARE
KÜPEŞTE
SQUARE
HANDRAIL**

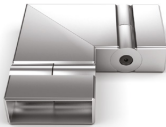
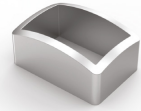
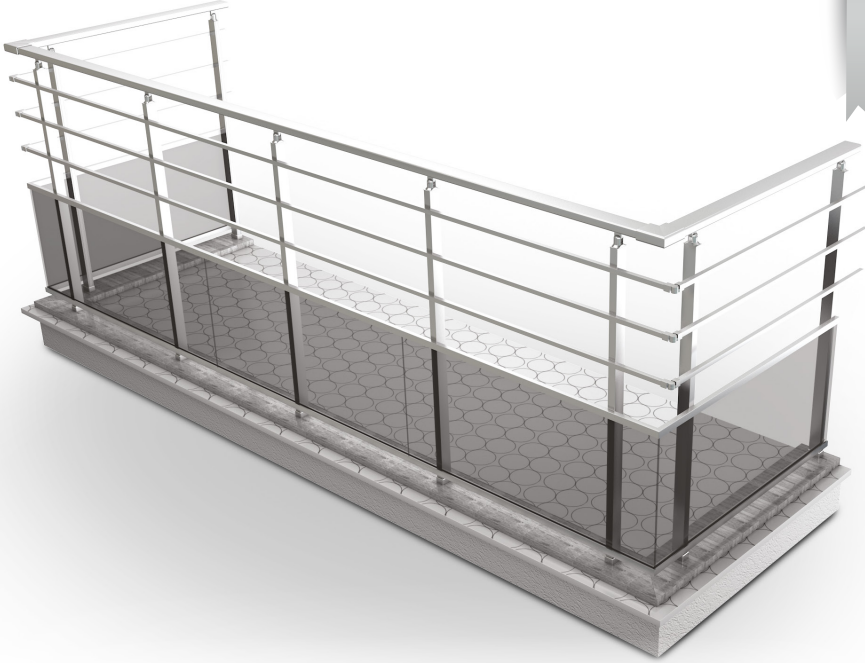

ÖZELLİKLER

- ▶ Merdiven, balkon, teras ve havuz kenarları gibi kullanım alanlarına estetik, görsellik ve uzun ömürlülük sağlayarak yapılarınıza değer katar.
- ▶ Malzemelerin temizlik dışında hiçbir bakım gerektirmez
- ▶ Uzun yıllar sorunsuz kullanım imkânı sağlar
- ▶ Paslanmaz ve korozyona dayanıklıdır.
- ▶ Sağlam ve hafif olması ile yapılarınızın mimari açıdan yük teşkil etmez.
- ▶ Hem iç, hem de dış mekânlarda rahatlıkla kullanılabilir.

FEATURES

- ▶ Adding value to your buildings by providing aesthetics, visuality and longevity to usage areas such as stairs, balconies, terraces and pool sides.
- ▶ Materials do not require any maintenance other than cleaning
- ▶ Provides unproblematic usage for many years
- ▶ It is stainless and corrosion resistant.
- ▶ Because of its durability and lightweight it does not be a burden to your building
- ▶ Can be used easily both inside and outside.



**OVAL
KÜPEŞTE
OVAL
HANDRAIL**

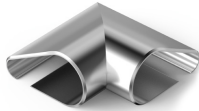

ÖZELLİKLER

- ▶ Merdiven, balkon, teras ve havuz kenarları gibi kullanım alanlarına estetik, görsellik ve uzun ömürlülük sağlayarak yapılarınıza değer katar.
- ▶ Malzemelerin temizlik dışında hiçbir bakım gerektirmez
- ▶ Uzun yıllar sorunsuz kullanım imkânı sağlar
- ▶ Paslanmaz ve korozyona dayanıklıdır.
- ▶ Sağlam ve hafif olması ile yapılarınızın mimari açıdan yük teşkil etemez
- ▶ Hem iç, hem de dış mekânlarda rahatlıkla kullanılabilir.

FEATURES

- ▶ Adding value to your buildings by providing aesthetics, visibility and longevity to usage areas such as stairs, balconies, terraces and pool sides.
- ▶ Materials do not require any maintenance other than cleaning
- ▶ Provides unproblematic usage for many years
- ▶ It is stainless and corrosion resistant.
- ▶ Because of its durability and lightweight it does not be a burden to your building
- ▶ Can be used easily both inside and outside.



**BAZA
KÜPEŞTE
BASE
SYSTEMS**

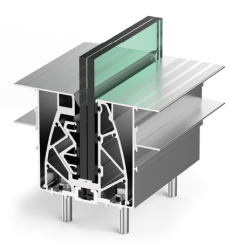
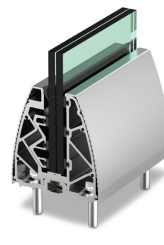
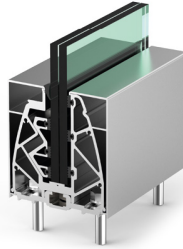
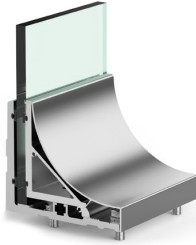
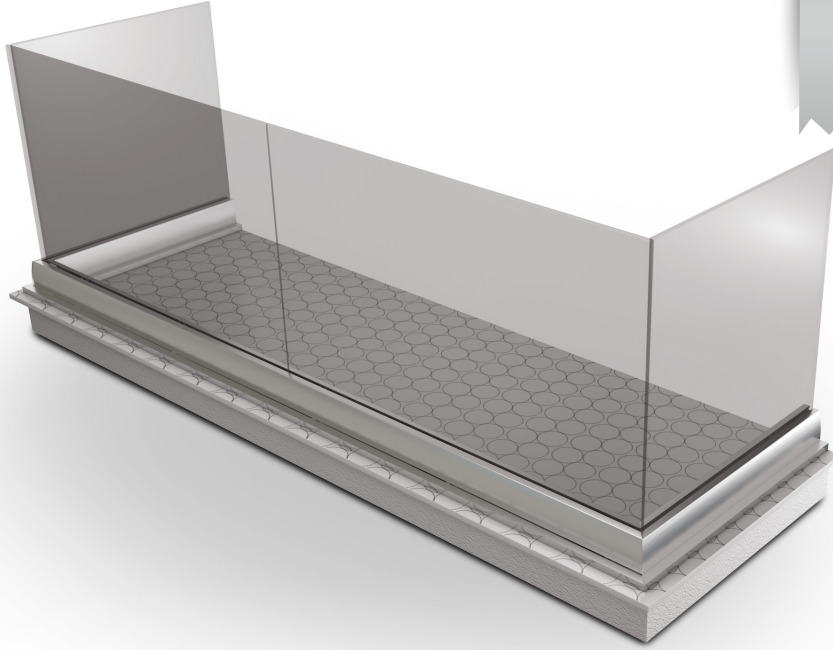

ÖZELLİKLER

- ▶ Sürekli destek profili ile ekstra sağlamlık
- ▶ Kolay ve hızlı montaj
- ▶ Hava koşullarına maksimum dayanıklılık
- ▶ Döşeme üstü ve altından montaj
- ▶ 10+10 mm 8+8 mm cam uygulama imkanı
- ▶ Farklı tutamak çeşitleri (oval, kare)
- ▶ Tüm eloksallı ve boyalı ürünler.

FEATURES

- ▶ Extra robustness with continuous support profile
- ▶ Easy and fast assembly
- ▶ Maximum resistance to weather conditions
- ▶ Installation onto and forehead of the floor
- ▶ Possibility to apply 10 + 10 mm 8 + 8 mm glass
- ▶ Different handle types (oval, square)
- ▶ All anodized and painted products.



LAMA
KÜPEŞTE
SHEET
SYSTEMS

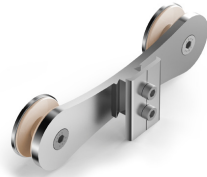
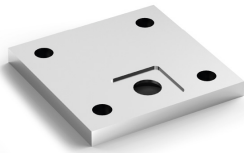
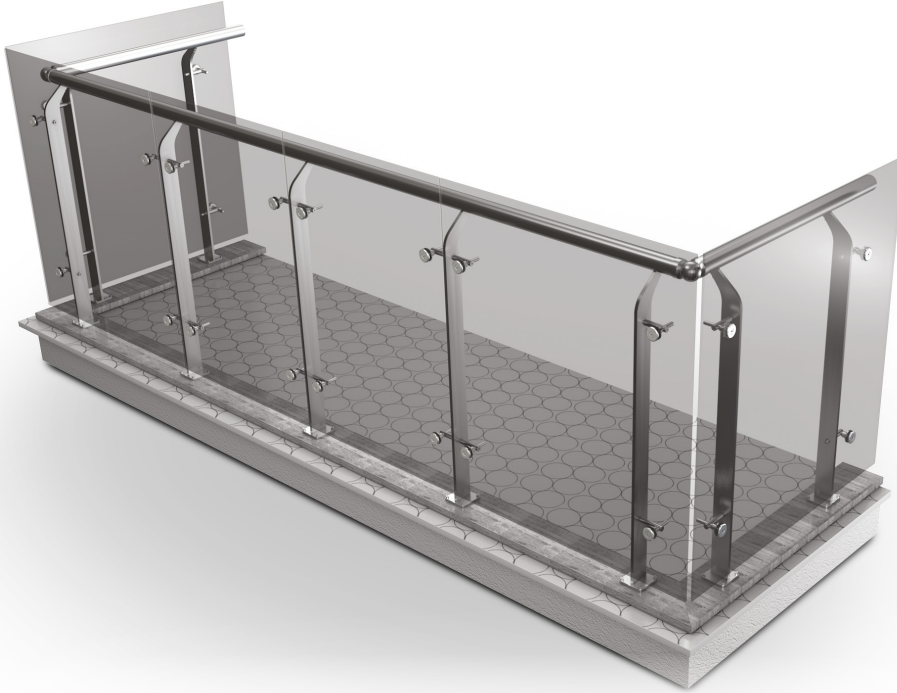

ÖZELLİKLER

- ▶ AVM, otel ve lüks yapılarda kullanılan bir sistemdir
- ▶ Geniş mesafeli temperli cam uygulamalarında güvenilir ve dayanıklı yapıya sahiptir
- ▶ Uzun yıllar sorunsuz kullanım imkânı sağlar
- ▶ Paslanmaz ve korozyona dayanıklıdır.
- ▶ Sağlam ve hafif olması ile yapılarınızın mimari açıdan yük teşkil etmez
- ▶ Hem iç, hem de dış mekânlarda rahatlıkla kullanılabilir.

FEATURES

- ▶ It is a system used in shopping centers, hotels and luxury buildings
- ▶ Reliable and durable structure for wide range tempered glass applications
- ▶ Provides trouble-free usage for many years
- ▶ It is stainless and corrosion resistant.
- ▶ Because of its durability and lightweight it does not be a burden to your building
- ▶ Can be used easily both inside and outside.



KARTELA - COLOR CHART - قائمة الالوان

TOZ BOYA POWDER PAINT الوان البودرة	AHŞAP DESEN WOOD PATTERN الالوان الخشبي	MAT RENKLER MATT COLORS الوان المت	PARLAK RENKLER BRIGHT COLORS الالوان اللامعة			
		A1		MB		PB
		A2		M0		P0
		A3		M1		P1
		A4		M2		P2
		A5		M3		P3
		A6		M4		P4
		A7		MAS		PAS
		A8		MKS		PKS

Since
1983

ALUMINIUM TRAILER PROFILE ◀◀◀



ÖZELLİKLER

- ▶ Alüminyum dorse profili, taşıma, depolama veya malzeme taşıma amaçları için kullanılan bir yapı malzemesidir.
- ▶ Alüminyum malzemesinden üretilir ve hafif, dayanıklı ve korozyona karşı dirençlidir.
- ▶ Dorse profili, römorklar, kamyonlar veya diğer taşıma araçlarının şasi yapımında kullanılır.
- ▶ Farklı boyutlar ve şekillerde mevcuttur ve çeşitli uygulamalara uygun olarak tasarlanabilir.
- ▶ Alüminyum dorse profilleri, taşımacılık endüstrisi ve diğer endüstriyel uygulamalarda sıkça tercih edilen bir yapı malzemesidir.



AD
DORSE

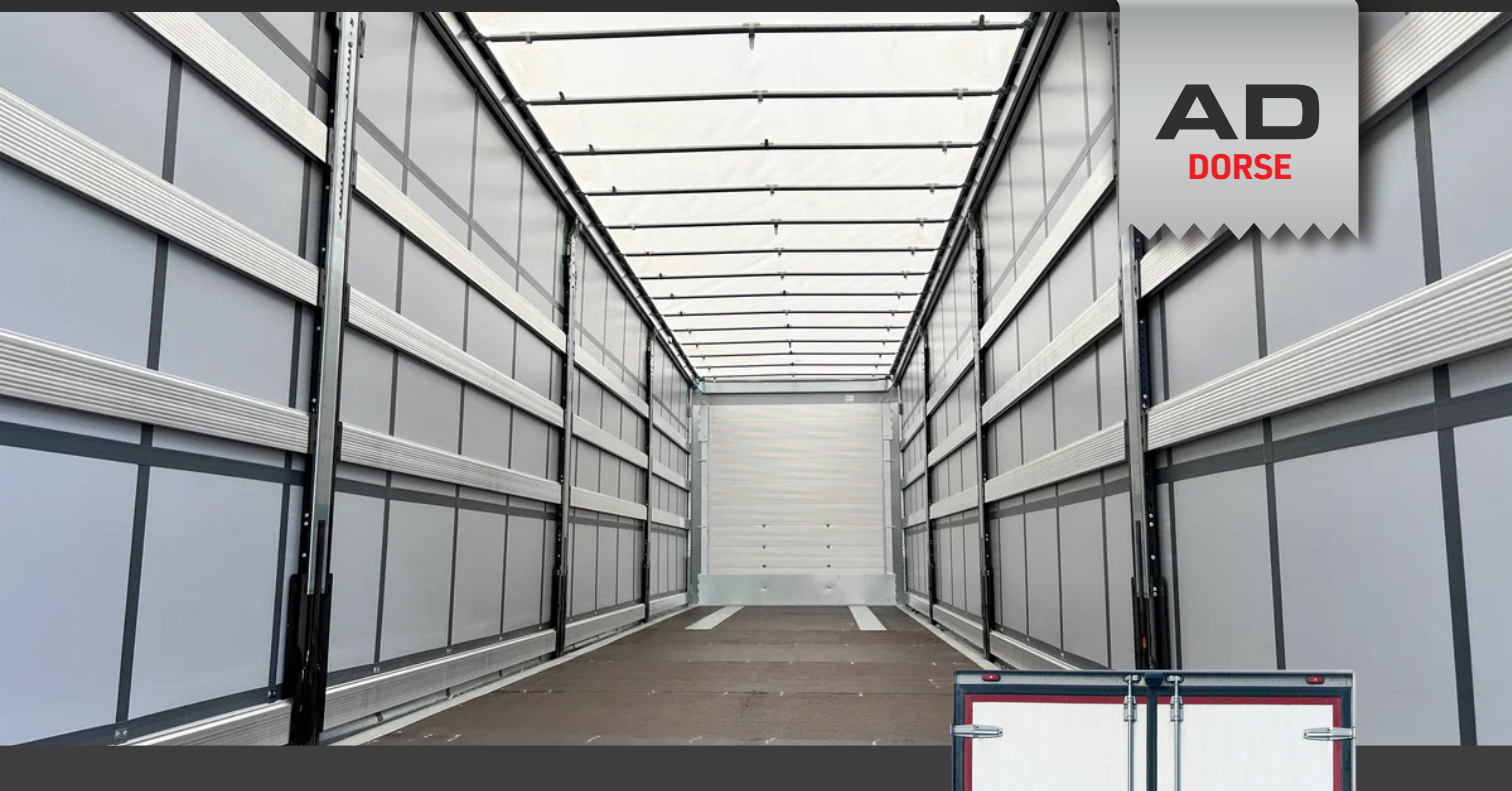

FEATURES

- ▶ Aluminium trailer profile is a building material used for transport, storage or material handling purposes.
- ▶ It is produced from aluminium material and is lightweight, durable and corrosion resistant.
- ▶ Trailer profile is used in the chassis construction of trailers, trucks or other transport vehicles.
- ▶ It is available in different sizes and shapes and can be designed to suit various applications.
- ▶ Aluminium trailer profiles are a frequently preferred building material in the transport industry and other industrial applications.







Since
1983







Fabrika / Factory

 Büyükkayacık Mah. T. Ziyaeddin Akbulut Cad. No: 20
Selçuklu / Konya / Türkiye
 +90 332 239 20 20 | Faks: +90 332 239 20 30
 ulusan@ulusan.com  www.ulusan.com



Mağaza / Show Room

 Marangozlar Sanayi Malkoç Sokak No: 18 42300
Selçuklu / Konya / Türkiye
 +90 332 237 34 67 | Faks: +90 332 237 34 70
 ulusan@ulusan.com  www.ulusan.com

